



motaxos
& sins
SINCE 1987

perambulator



thank you for your kind
interest in my work.

this collection is a result
of my over 35 year
fascination with the art
of music reproduction
from concert recording,
electrical engineering and
ultimately, artistic design
to produce objects that
allow you to "be there".

each object is totally
handcrafted by either
myself or one of my sons.

i consider them all
objects of art.

kostas motaxos

K-DESIGN AWARD'18

May 30, 2018

METAXAS

AWARD WINNER

TITLE METAXAS STATEMENT

COUNTRY NETHERLANDS

AFFILIATION METAXAS & SINS

This certificate of award is presented in recognition of submission of works with creativity and efforts to the K-DESIGN AWARD 2018.

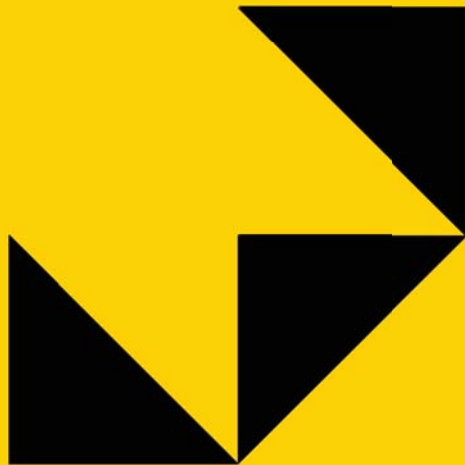

2018 WINNERS

PRODUCT DESIGN

Presented to

Metaxas & Sins Bv

Design

Metaxas & Sins Statement
Amsterdam, Netherlands

Client

Metaxas & Sins

Lead Designer

Kostas Metaxas

Metaxas & Sins Statement has been identified as one of the leading product design by the professional jury of APDC*IDA. Kostas Metaxas is a winner of the APDC*IDA 2018 Design Excellence Awards.



Design Excellence Awards

Astrid Hebert
Vice President
International Design Awards (IDA)

Hossein Farmani
President
International Design Awards (IDA)

Jason Wang
Secretary-General
Asia Pacific Design Center (APDC)

PROFESSOR
KEN NAH

PROFESSOR
ANDY LAW

PROFESSOR
SHINGO ANDO

PROFESSOR
SUNAH KIM

perambulator

The Metaxas PPI uses a sensuous organic shape which is non-mirror image, CNC'd from a block of solid 6061 aircraft grade aluminium [or Titanium] to eliminate the usual reflections and refractions of resonances inherent in all turntables constructed from pure geometric shapes.

Metaxas constructs the round platter in such a way that the boundary between the lathe-turned aluminium base has organic undulations connecting it to a dedicated acrylic platter mat.

The recessed "label area" adds another level of isolation and evacuation.

An ultra-precision voltage regulated belt-drive system featuring the most advanced Swiss Maxon motor rotates the platter without adding any external speed variations or vibrations.

PARTS LIST:

Your Perambulator comes standard with the following accessories:

1. 3 x 2mm [x 300mm] neoprene rubber belts.
2. Vial of Bearing Fluid [very little is required]
3. Spirit Level
4. Set of Alun wrench keys from 1.5mm to 4mm
5. Spare synthetic diamond 10mm ball.





**ULTIMATE TURNTABLE
MAIN BEARING OIL**
INSTRUCTIONS

Shake bottle well before use. Remove bearing spindle from housing. Clean spindle and bearing housing. Apply a few drops of oil to bearing spindle in housing and allow to settle. Do not force down. Bearings are different sizes. If you have put too much oil in and it leaks from top of housing, just repeat process with less oil. Take care not to allow oil to come in contact with drive belt or any driving surfaces. Always use clean hands and



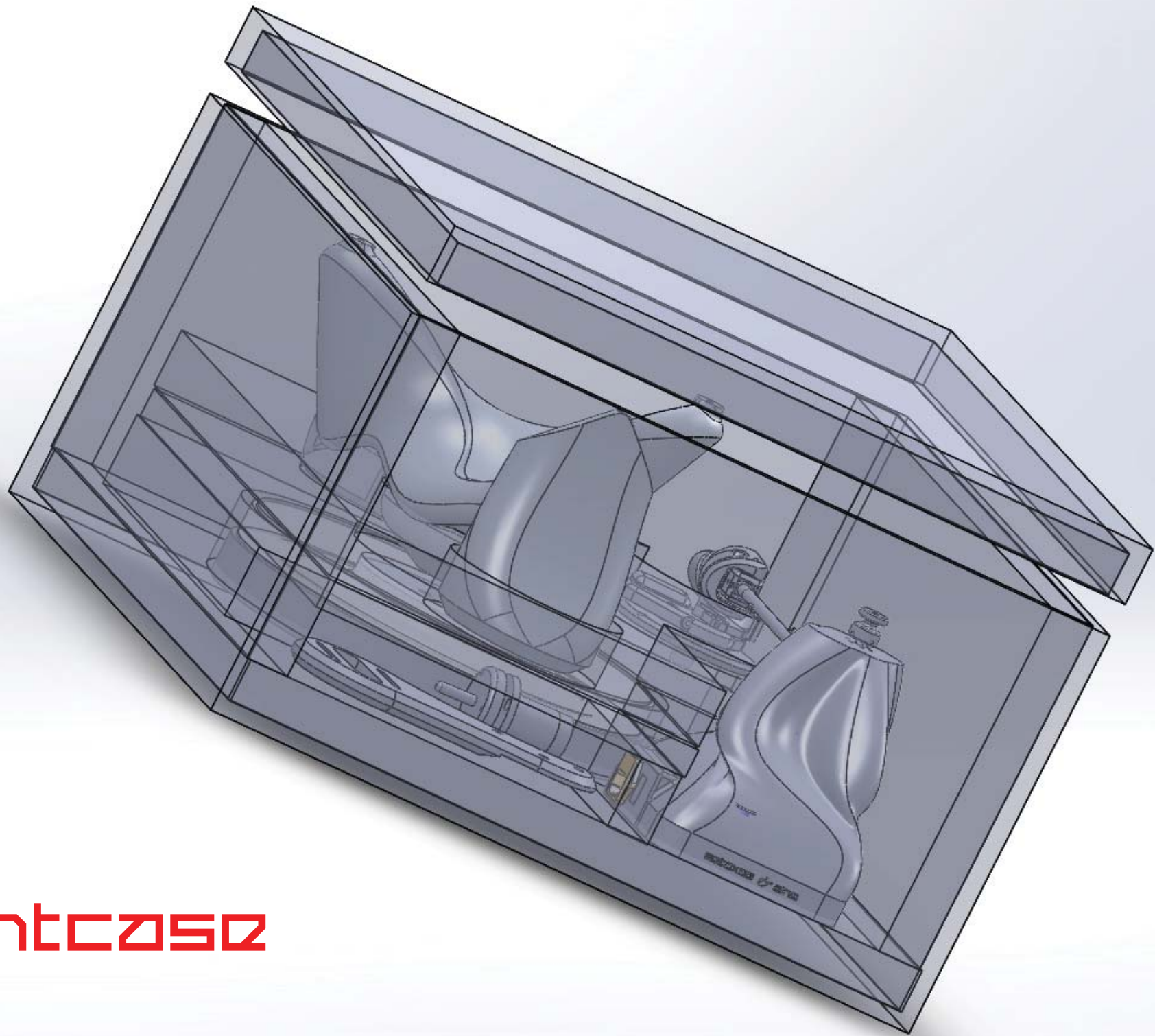

Flightcase

The Flightcase inside the external cardboard box is insulated with a 10mm foam surround to cushion the Perambulator in transit to its final destination. Please carefully unpack the contents onto a large bench/table for assembly.

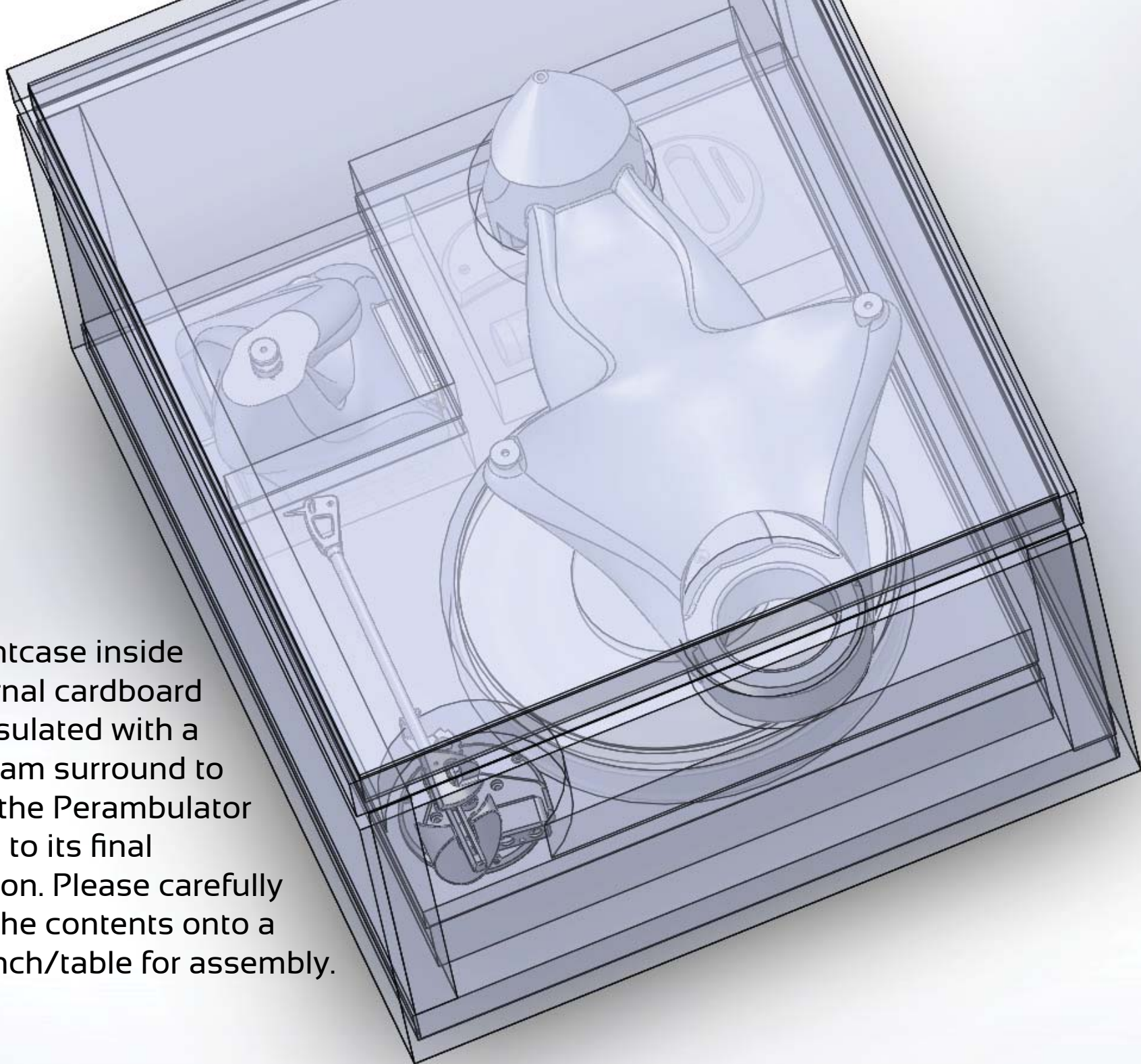



Choose from two tonearm mounting options, both precut for our Combobulator Tonearm or any other Universal Tonearm.





The Stainless Steel Bearing housing is precision machined to 0.02mm tolerances to ensure that the sintered bronze sleeve fits snugly as does the mirror-finish polished bearing.



A close-up photograph of a white, spherical synthetic diamond ball bearing. The bearing is held in place on a circular metal plate by four strips of teal tape arranged in a cross pattern. The metal plate has several screws around its perimeter. In the background, there are red circular components and a black surface. A small white label with handwritten text is visible in the lower-left corner.

A 10mm synthetic DIAMOND ball bearing against a sapphire thrust plate and conical stainless-steel shaft supports the huge platter.

ZnO₂
10 mm
1

ck

A close-up photograph showing a hand holding a highly polished, cylindrical stainless steel shaft. The shaft is being held vertically above a circular bearing housing. The housing has a central hole and two screws on its side. The background is a blurred red surface. The lighting highlights the reflective surface of the steel shaft.

Extra-thick 15mm ultra-polished, antimagnetic 304 Stainless Steel shaft glides "frictionless" against the "sintered bronze" bearing.

Simply drizzle a very small amount of the supplied bearing oil onto the bearing shaft and approximately 5mm of the bottle height of oil into the bearing housing.

Very little oil is used.

ULTIMATE TURNTABLE MAIN BEARING OIL

INSTRUCTIONS

Shake bottle well before use. Remove bearing spindle from housing. Clean spindle and bearing housing. Apply a few drops of oil to bearing spindle in housing and allow to settle. Do not force down. Bearings are different sizes - if you have put too much oil in and it leaks from top of housing, don't worry - you haven't damaged anything, just repeat process with less oil. Take care not to allow oil to contaminate drive belt or any driving surfaces. Avoid contact with Graphite.

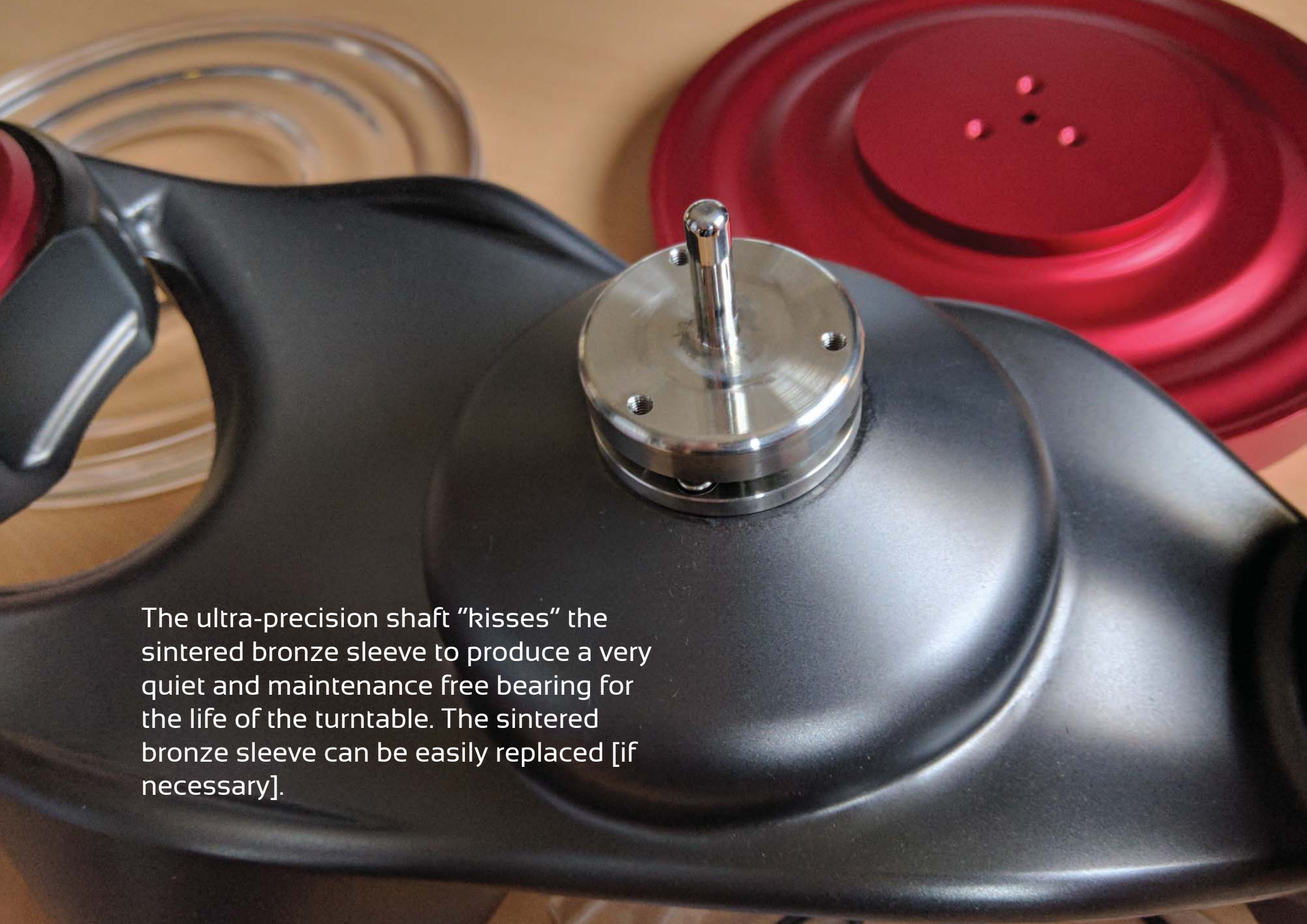

A close-up photograph of a turntable's central shaft assembly. The main body is a dark, matte black plastic. In the center, a polished metal shaft with a rounded top is mounted on a stack of three cylindrical metal components. The top component is a sintered bronze sleeve, which is in contact with the shaft. The shaft has four small holes around its base. In the background, a red circular component with three small holes is visible, and a clear plastic ring is partially seen on the left.

The ultra-precision shaft "kisses" the sintered bronze sleeve to produce a very quiet and maintenance free bearing for the life of the turntable. The sintered bronze sleeve can be easily replaced [if necessary].



Three countersunk stainless steel M4 bolts connect the huge platter to the bearing making it easy to assemble.



ACCESSORIES





Please note that the belt turns the acrylic platter mat, NOT the aluminium platter.

perambulator motor

A ultra-precise and quiet MAXON motor with its proprietary controller keeps the speed absolutely stable.

We've designed the Perambulator to operate at exactly 33.3 and 45 RPM [switchable] for the 2mm thick rubber belts that we supply.

If absolutely necessary, the motor can be easily re-programmed by USB for other belt types/diameters using the ESCON Software provided by MAXON with a standard WINDOWS 10 [Ten] OS [operating software] computer.



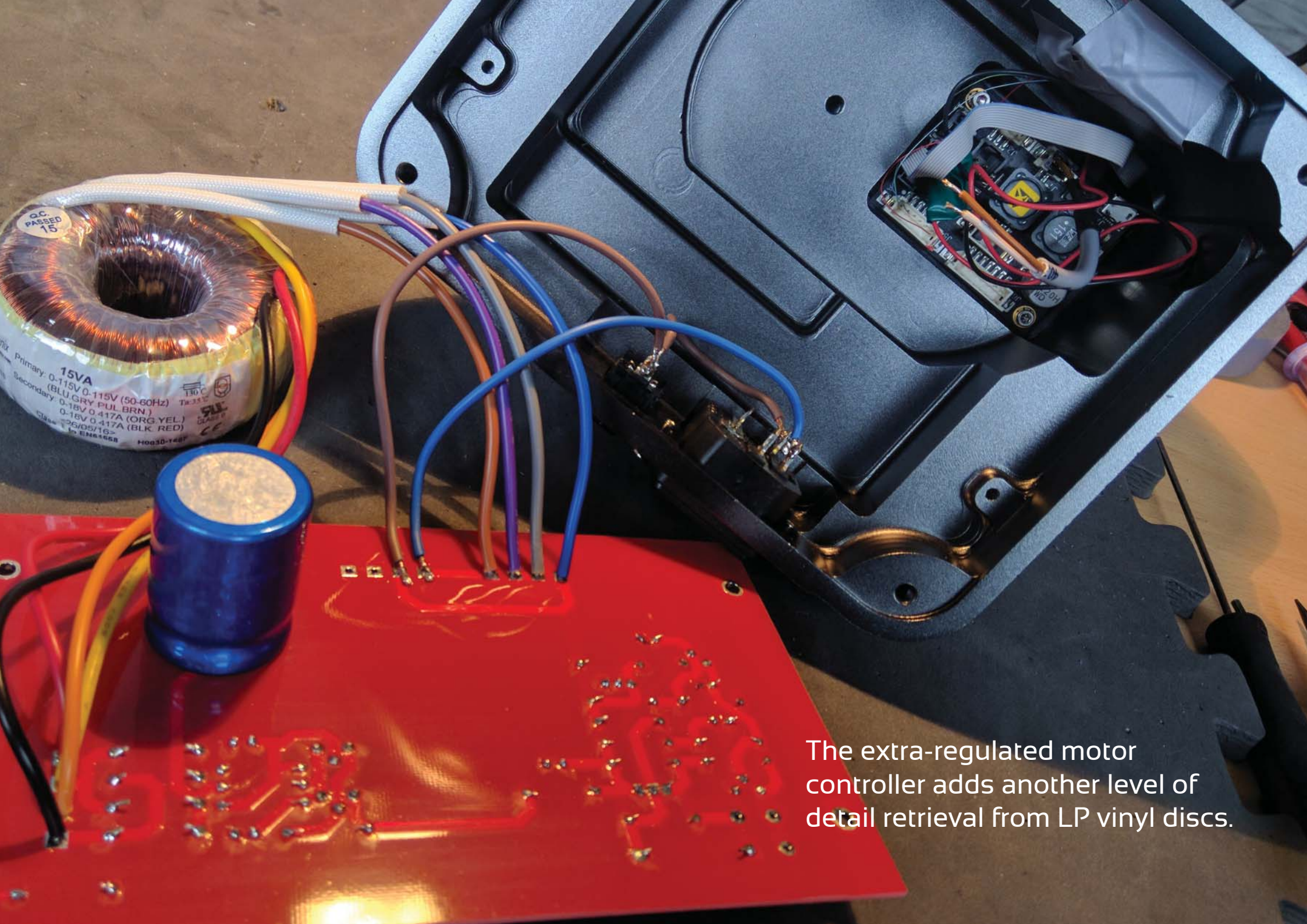

The extra-regulated motor controller adds another level of detail retrieval from LP vinyl discs.



programming
the motor

ESCON Studio 2.2 - [Controller Monitor]

File View Tools Window Help

Active Controller ESCON 36/2 DC - USB0

Tools

Configuration

- Startup Wizard
- Regulation Tuning
- Firmware Update
- Diagnostics

Operation

- Controller Monitor
- Parameters
- Data Recorder

Dynamic Help

Contents

Startup Wizard

- Motor / Sensors
- Controller
- Inputs / Outputs

Controller Monitor

Startup Wizard - ESCON 36/2 DC

Introduction

The ESCON 36/2 DC is a small-sized, powerful 4-quadrant PWM servo controller for the highly efficient control of permanent magnet-activated DC motors up to approximately 72 Watts.



Help Contents

Motor/Sensors

Controller (Closed Loop) 0.0 rpm

250.0 rpm/s

250.0 rpm/s

maxon DC motor 0.000

Status

0 Errors 0 Warnings Hide

Type	Name	Description	Solution
------	------	-------------	----------

Ready Standard Controller Paused

ESCON Studio 2.2 - [Controller Monitor]

File View Tools Window Help

Active Controller ESCON 36/2 DC - USB0

Tools

Configuration

- Startup Wizard
- Regulation Tuning
- Firmware Update
- Diagnostics

Operation

- Controller Monitor
- Parameters
- Data Recorder

Dynamic Help

Contents

Startup Wizard

- Motor / Sensors
- Controller
- Inputs / Outputs

Controller Monitor

Startup Wizard - ESCON 36/2 DC

Motor Data

Enter motor characteristics (consult maxon catalog for motor data).

Speed Constant: 140.6 rpm/A

Thermal Time Constant Winding: 44.0 s

Motor/Sensors

Controller (Closed Loop) 0.0 rpm

250.0 rpm/s

250.0 rpm/s

maxon DC motor 0.000

Status

0 Errors 0 Warnings Hide

Type	Name	Description	Solution
------	------	-------------	----------

Ready Standard Controller Paused

ESCON Studio 2.2 - [Controller Monitor]

File View Tools Window Help

Active Controller ESCON 36/2 DC - USB0

Tools

Configuration

- Startup Wizard
- Regulation Tuning
- Firmware Update
- Diagnostics

Operation

- Controller Monitor
- Parameters
- Data Recorder

Dynamic Help

Contents

Startup Wizard

- Motor / Sensors
- Controller
- Inputs / Outputs

Controller Monitor

Startup Wizard - ESCON 36/2 DC

System Data

Enter system data.

Max. Permissible Speed: 1215.0 rpm

Nominal Current: 1.1700 A

Max. Output Current Limit: 4.0000 A

Motor/Sensors

Controller (Closed Loop) 0.0 rpm

250.0 rpm/s

250.0 rpm/s

maxon DC motor 0.000

Status

0 Errors 0 Warnings Hide

Type	Name	Description	Solution
------	------	-------------	----------

Ready Standard Controller Paused

ESCON Studio 2.2 - [Controller Monitor]

File View Tools Window Help

Active Controller ESCON 36/2 DC - USB0

Tools

Configuration

- Startup Wizard
- Regulation Tuning
- Firmware Update
- Diagnostics

Operation

- Controller Monitor
- Parameters
- Data Recorder

Dynamic Help

Contents

Startup Wizard

- Motor / Sensors
- Controller
- Inputs / Outputs

Controller Monitor

Startup Wizard - ESCON 36/2 DC

Speed Sensor

Select type of sensor.

Digital Incremental Encoder

Encoder Resolution: 1024 Counts/turn

Encoder Direction: maxon Inverted

Channel A

Channel B

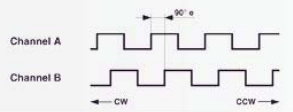

Motor/Sensors

Controller (Closed Loop) 0.0 rpm

250.0 rpm/s

250.0 rpm/s

maxon DC motor 0.000

Status

0 Errors 0 Warnings Hide

Type	Name	Description	Solution
------	------	-------------	----------

Ready Standard Controller Paused

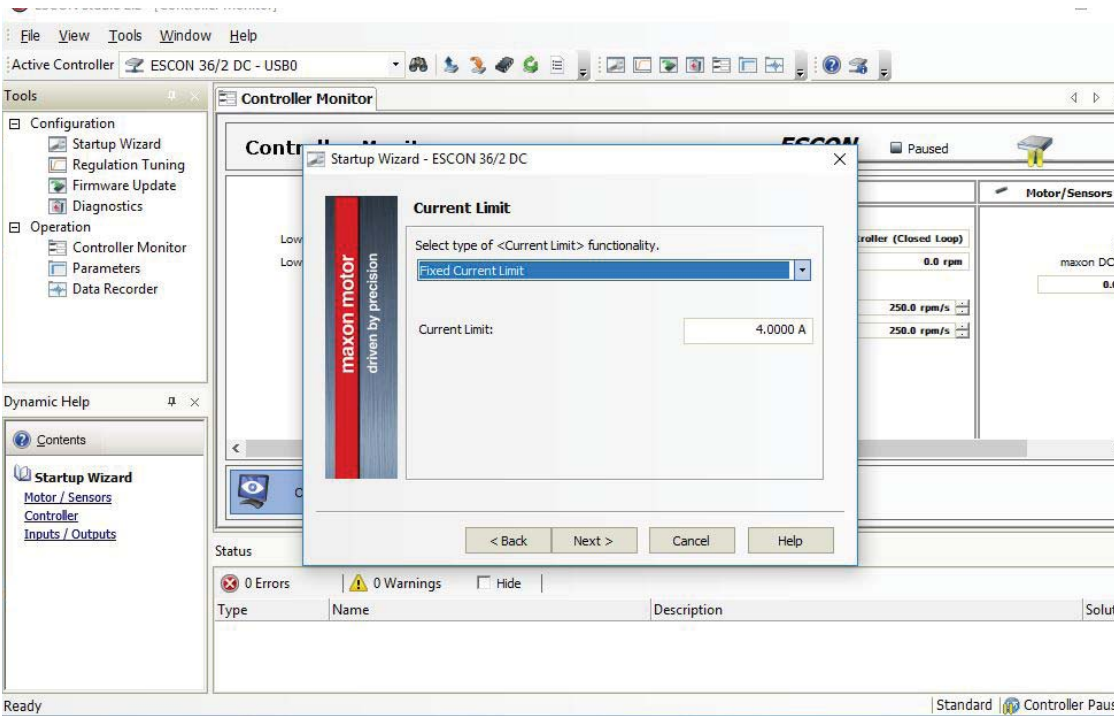
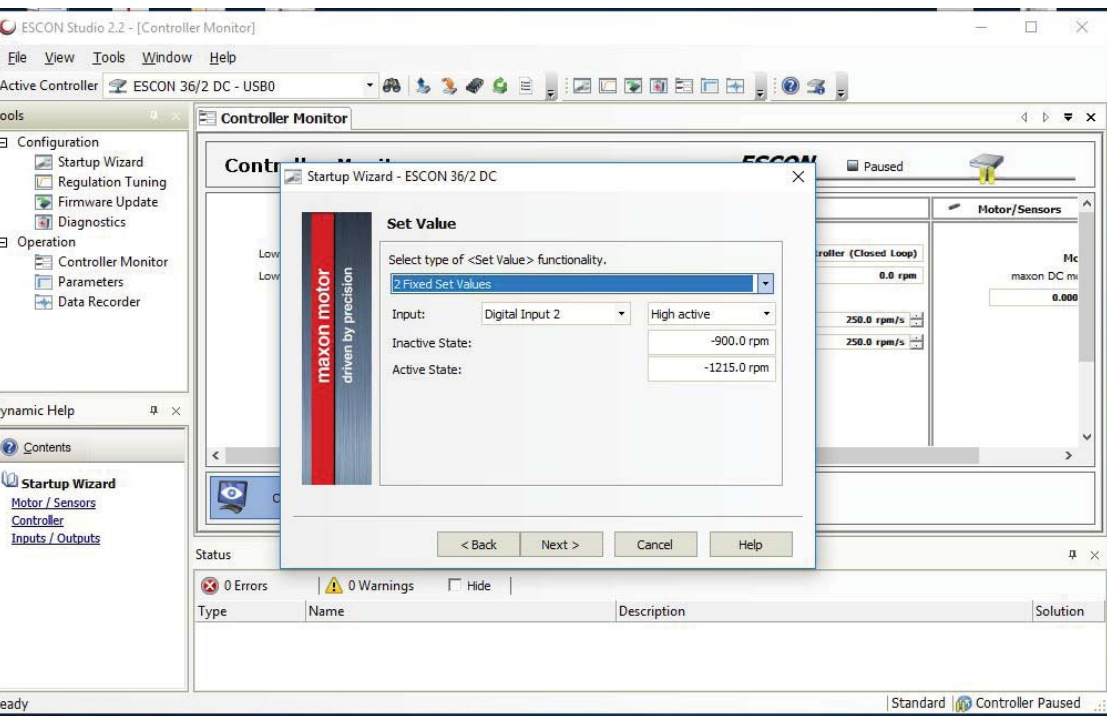
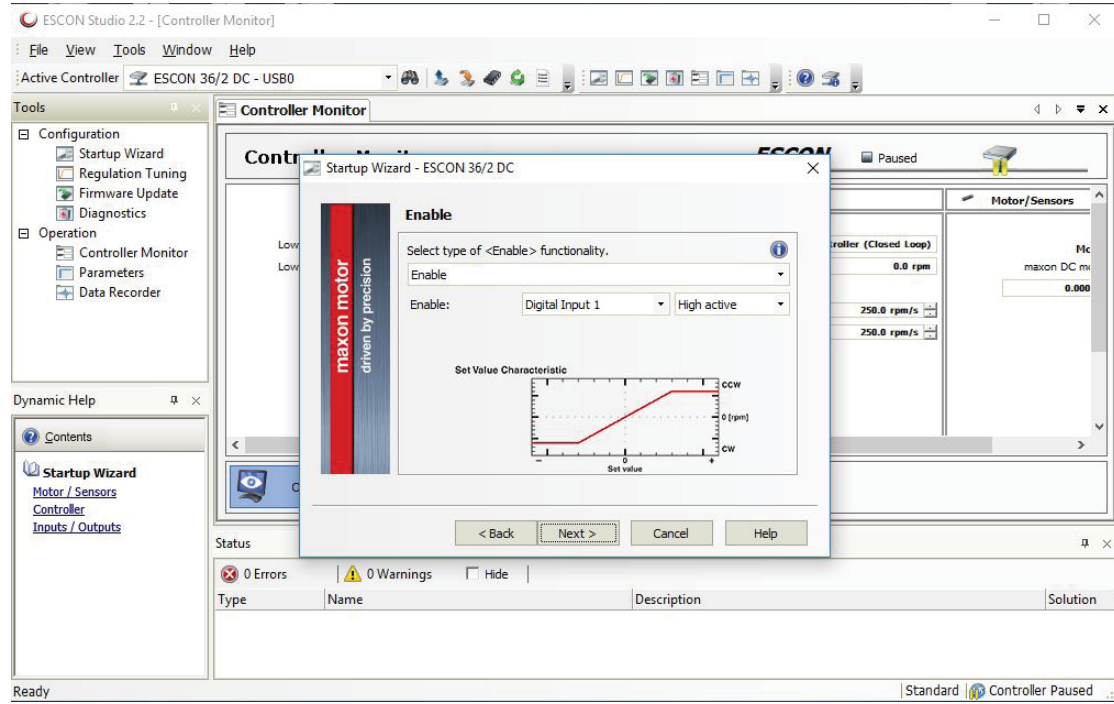
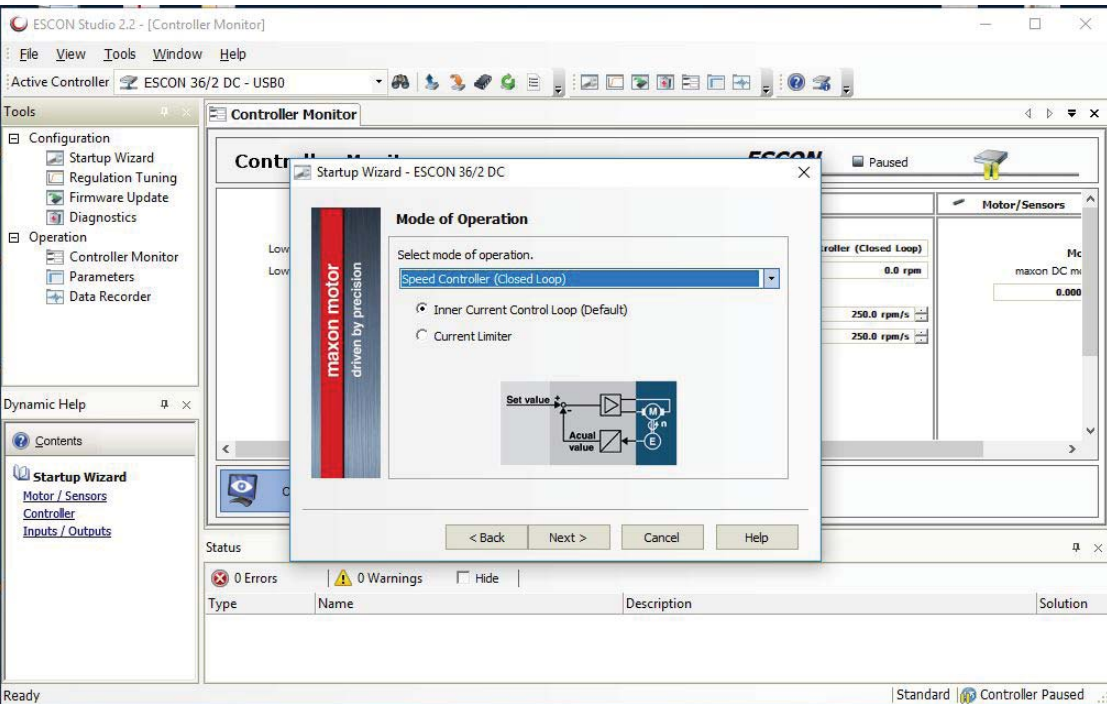

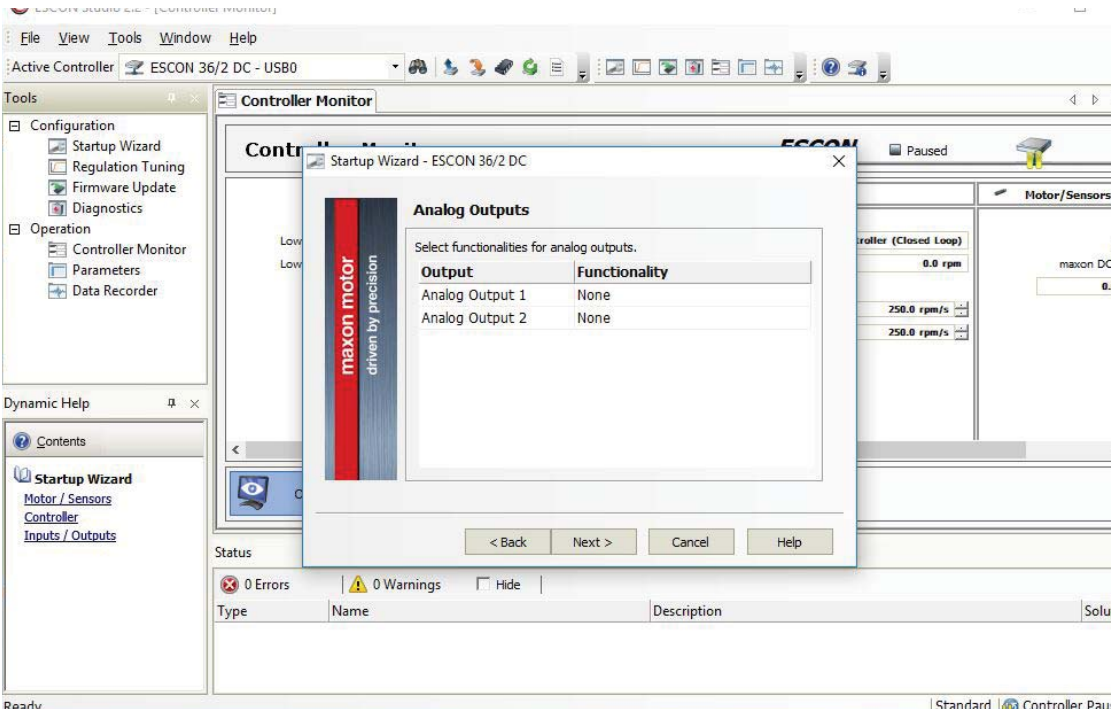
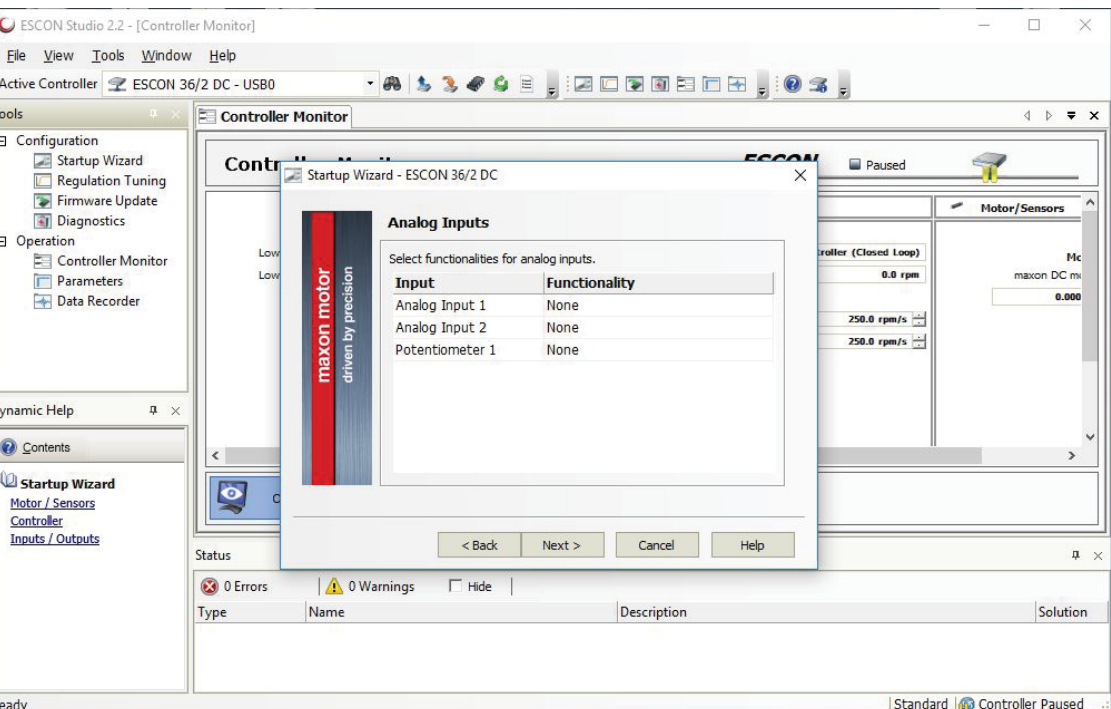
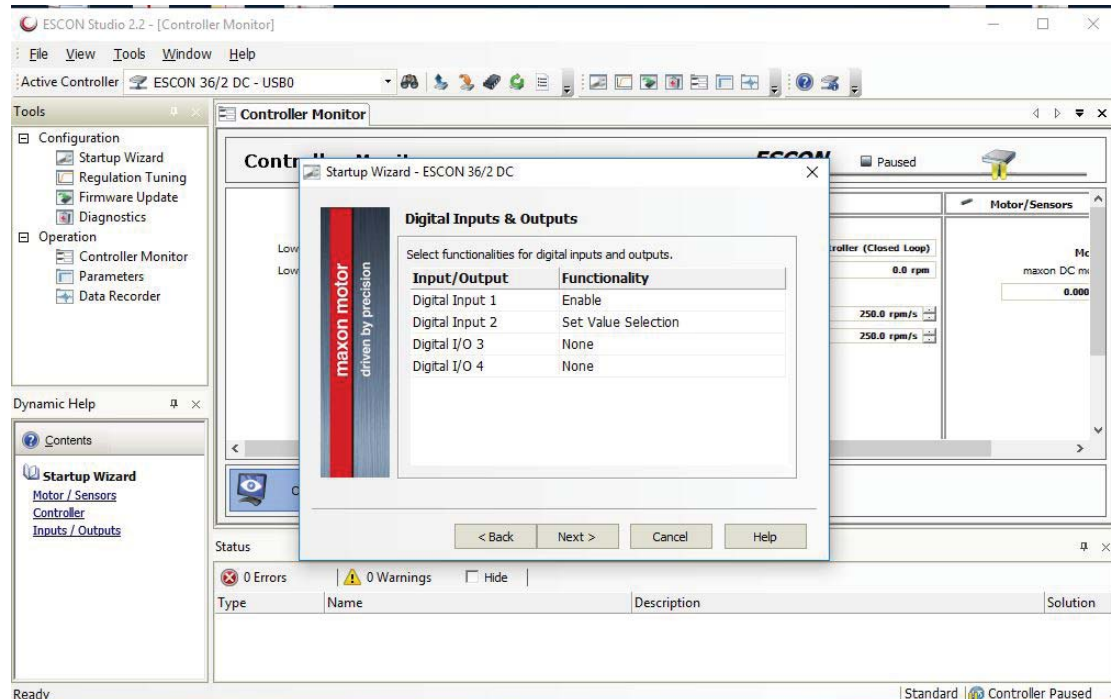
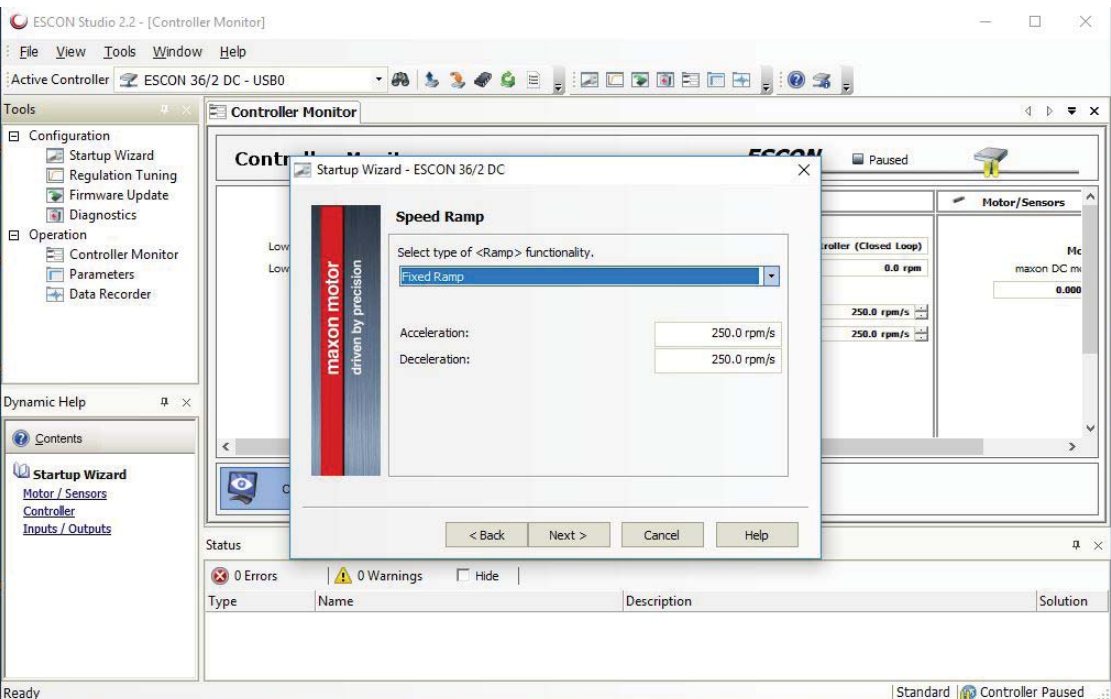

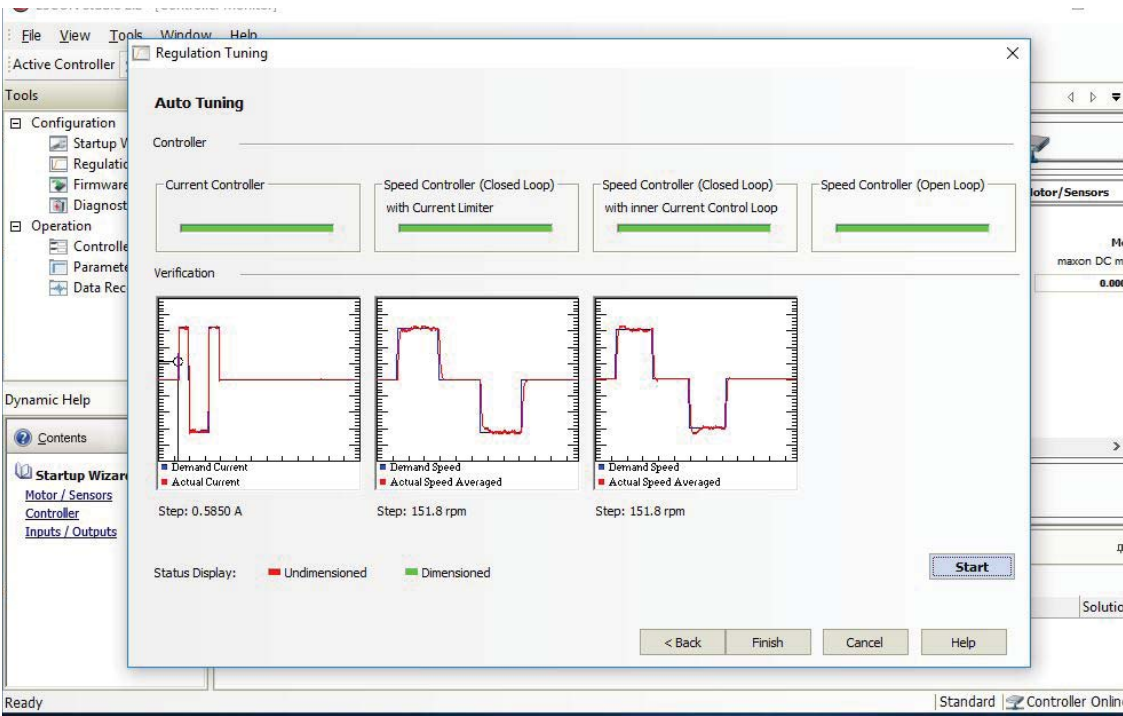
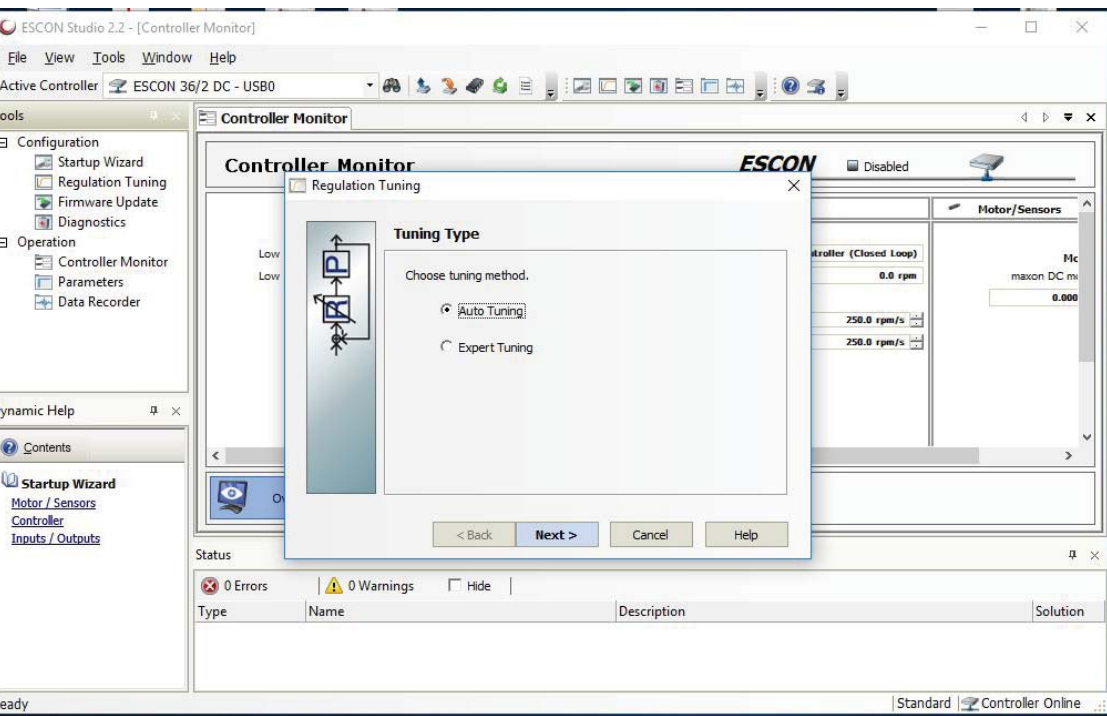
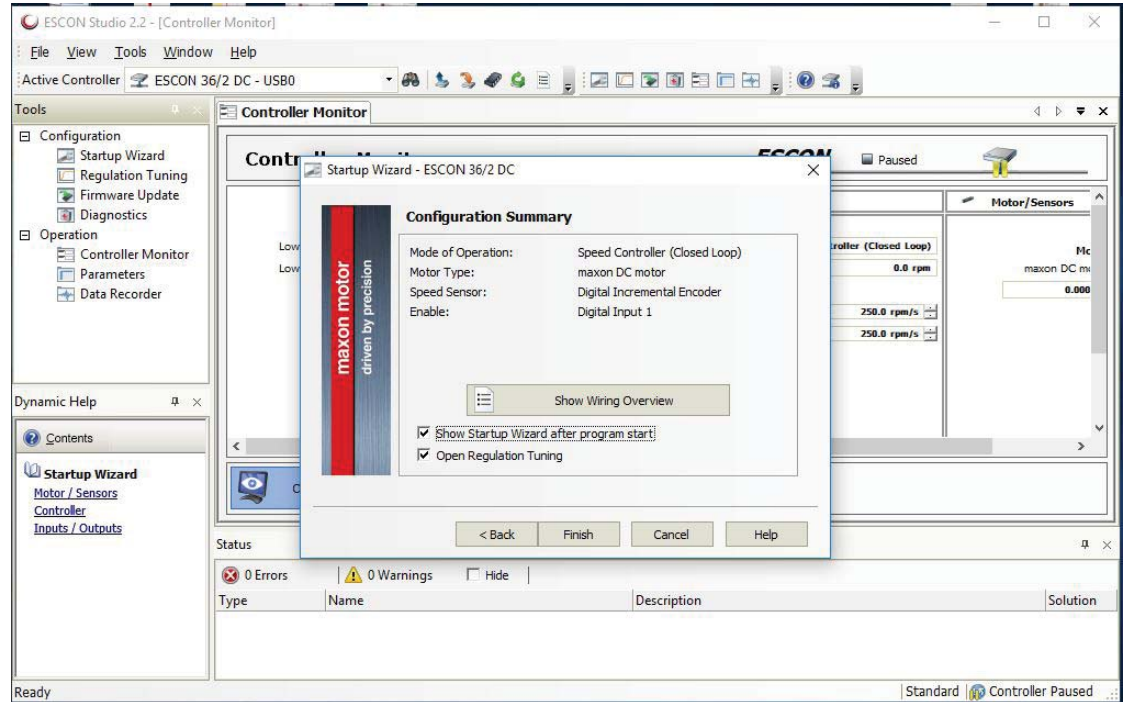
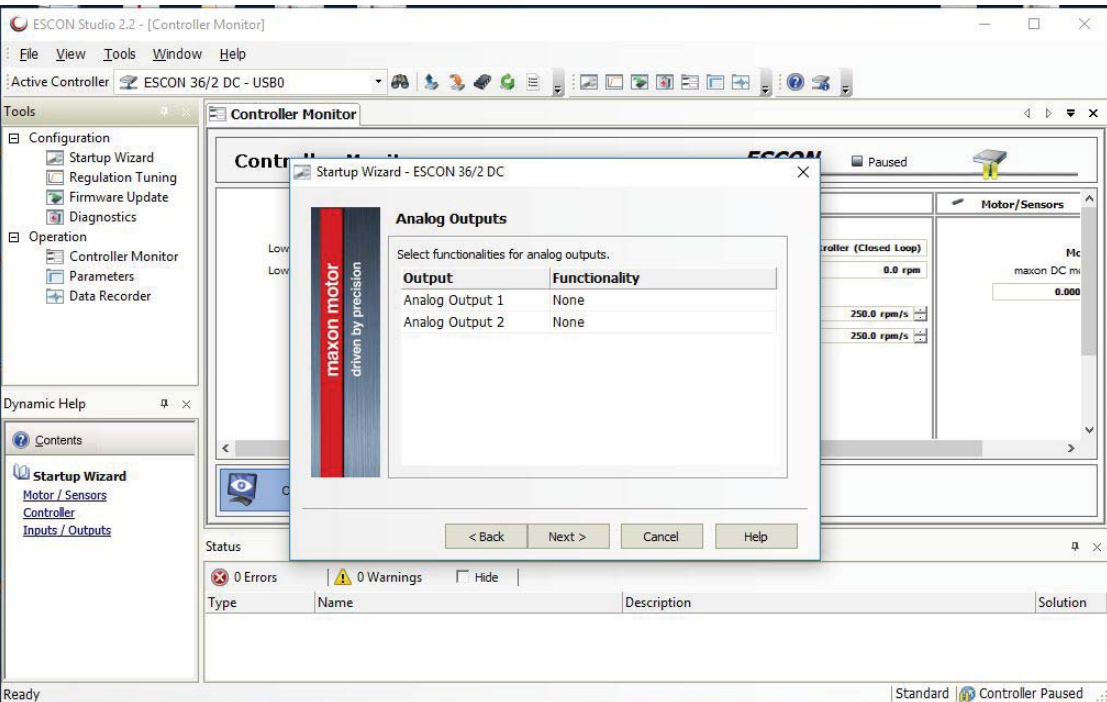

perambulator bearing

A great bearing is simply
“precision engineering”.

We started with antimagnetic 304
Stainless Steel to produce a VERY
inert structure that not only
supports, but doesn't react in any
way to the oils and additives used
in the bearing.

We auditioned sintered bronze
bearings from 3 manufacturers
and settled on one that seems to
have the necessary attributes of
precision [no slack] and correct
oil impregnation.

Finally, we selected a solid 1mm
thick sapphire disc to act as a
thrust plate for the precision 10mm
zirconium [synthetic diamond] ball.





www.motaxos.com