



motaxos & sins  
depuis 1987  
solitaire

thank you for your  
kind interest in my  
work.

this amplifier is the  
result of my 35  
year fascination  
with the art of  
music reproduction  
from concert  
recording,  
electrical engineering  
and ultimately,  
artistic design.

this solitaire has  
been totally  
handcrafted by  
either myself or  
one of my sons.

i consider it an  
object of art.

**kostas mataxas**





**solitaire**

metallic automotive paint option

# specifications

The Solitaire is a straight 150WRMS Stereo Power Amplifier or can be offered like the IKARUS as a higher powered [150WRMS] Stereo Integrated Amplifier.

It best embodies the sculptural design and "lack-of-sound" philosophy of Metaxas & Sins.

After over 35 years of work in the field of High End Audio, from the design and manufacturing of entire playback systems to the recording of over 300 acoustic concerts to gain further musical insights, the last thing that artist-designer Kostas Metaxas wanted to produce was "another box with transistors on a heatsink".

Kostas was dreaming of the most spectacular architecture, design and sculpture he had experienced and wanted to bring that emotional intensity, daring and seductive beauty to an audio amplifier.

As a recording engineer, Metaxas also wanted to "voice it" for extremely realistic recording playback, to be able to reproduce all the nuance and emotion of a musical performance.

His new SOLITAIRE is the result. Machined from a solid block of either aircraft aluminium, copper or titanium, it's totally bespoke and the modular electronics make it future-proof. Even the circuit boards can be CNC machined from 1mm solid silver coated clear polystyrene.

From the sensual, organic and striking casework [inspired by the stunning work in Sports cars of the 1950's/60's of Ercole Spada, as well as the architecture of Hadid, Gehry and Calatrava] to absolutely every part of the amplifier including the circuit, topology, layout and casework has been developed by Kostas Metaxas. It is the logical evolution of his groundbreaking design concepts pioneered in the early 1980's.

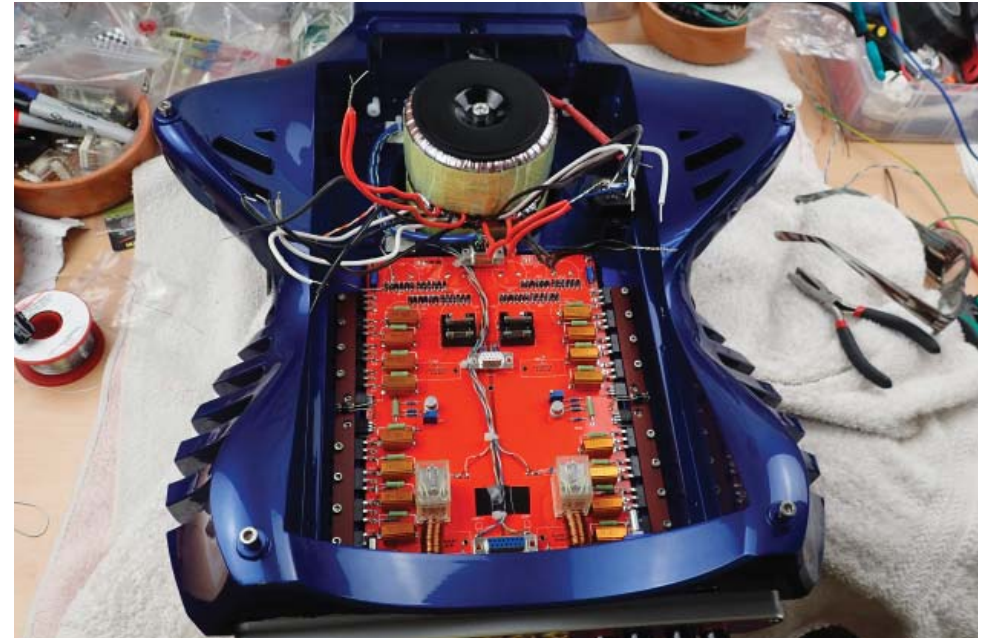



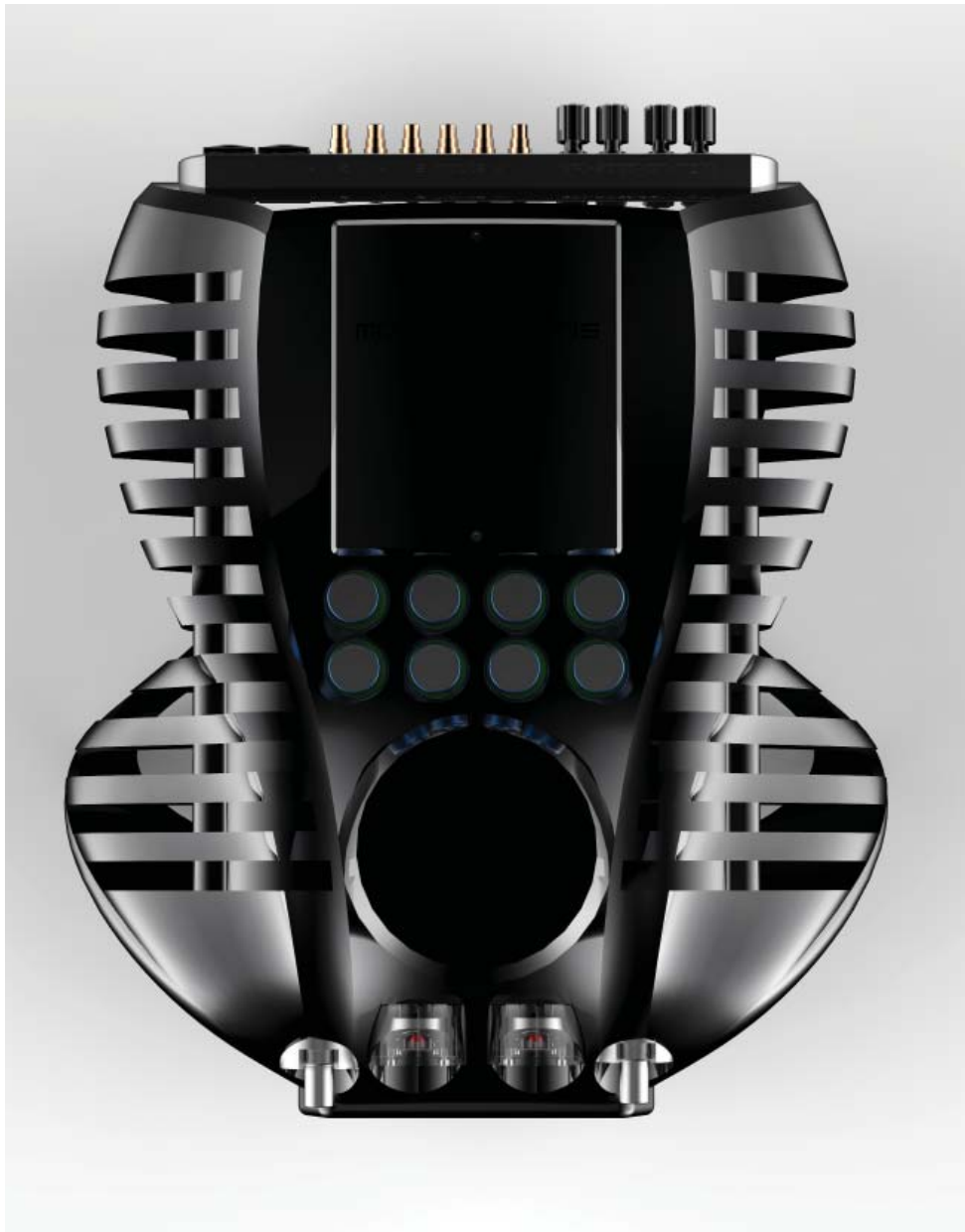

Then, in true “Bugatti fashion”, each and every amplifier is assembled by the master or his sons — either Andreas or Alessandro Metaxas.

The individually 5-axis CNC’d “sculptural” enclosure presents a very heavy, solid, inert, non-resonant structure to RFI shield and ultimately protect the delicate electronic signals, driving the noise floor to ultra-ultra-low levels, revealing a wealth of detail that has never been heard before.

#### 1. INPUT STAGE:

The fully complementary, dual differential, cascaded input stage is linearised to ensure least distortion over the large voltage swings to the amplifier input from the preceding preamplifier. A very gradual (6dB/octave) Bessel filter is incorporated at the input to eliminate the needless reproduction of Radio Frequencies. The second voltage gain stage uses considerable local feedback to ensure that large voltage swings from the input stage are accommodated with the least possible distortion. An overall negative feedback of only 11dB is required to stabilise the complete D.C. operating point and reduce distortion at full power to below 0.01% T.H.D. which is primarily composed of second harmonics. A D.C. servo is built around an integrated circuit to monitor the output voltage and ensure absolute D.C. stability at all times.

#### 2. OUTPUT STAGE:

Our triple Darlington output stage uses the fastest power transistors that were previously available, but no longer available since the factory in Japan was destroyed by a Tsunami. Fortunately, we purchased large stocks of these devices 30 years ago.

Our printed circuit design borrows techniques from RF and UHF groundplane technology to maximise the speed of current delivery, especially at high frequencies. From the ultra high-speed (FT’s 150 MHz) power transistors.



### 3. POWER SUPPLY INPUT & OUTPUT STAGE:

The input voltage gain stage of the SOLITAIRE is isolated via the high-current output stage via a two stage 'capacity-multiplier' circuit which uses the beta of the transistors to multiply the filtering effect of the capacitor used. The simplicity of this circuit allows the elimination of any output bypassing capacitors which would otherwise reduce the apparent speed and degrade the sound quality of this amplifier.

4. PROTECTION CIRCUITS: To eliminate the sonic colourations imposed by sophisticated current limiting protection circuits, the SOLITAIRE uses only the short M205 fuse types to protect the high current stages. Apart from the fuses is a four pole relay in series with the loudspeaker connections. If over 0.6VDC is sensed at the amplifier output, the relay is activated until the condition is rectified.

FREQUENCY RESPONSE : DC - 5.0MHz (-3dB)

POWER OUTPUT: 150WRMS per channel into 8 Ohms with no more than 0.05% T.H.D.

DAMPING FACTOR : Greater than 500 wide band

SLEW RATE : Greater than 1000V/us small and large signal

T.H.D. : Less than 0.05% 20Hz-20KHz

I.M.D.(S.M.P.T.E.) : Less than 0.05%

SIGNAL/NOISE : -117DBV unweighed input shorted

SENSITIVITY: 0.5VRMS in for 150WRMS out (28dB)

INPUT IMPEDANCE : 100kOhms in parallel with 11pF

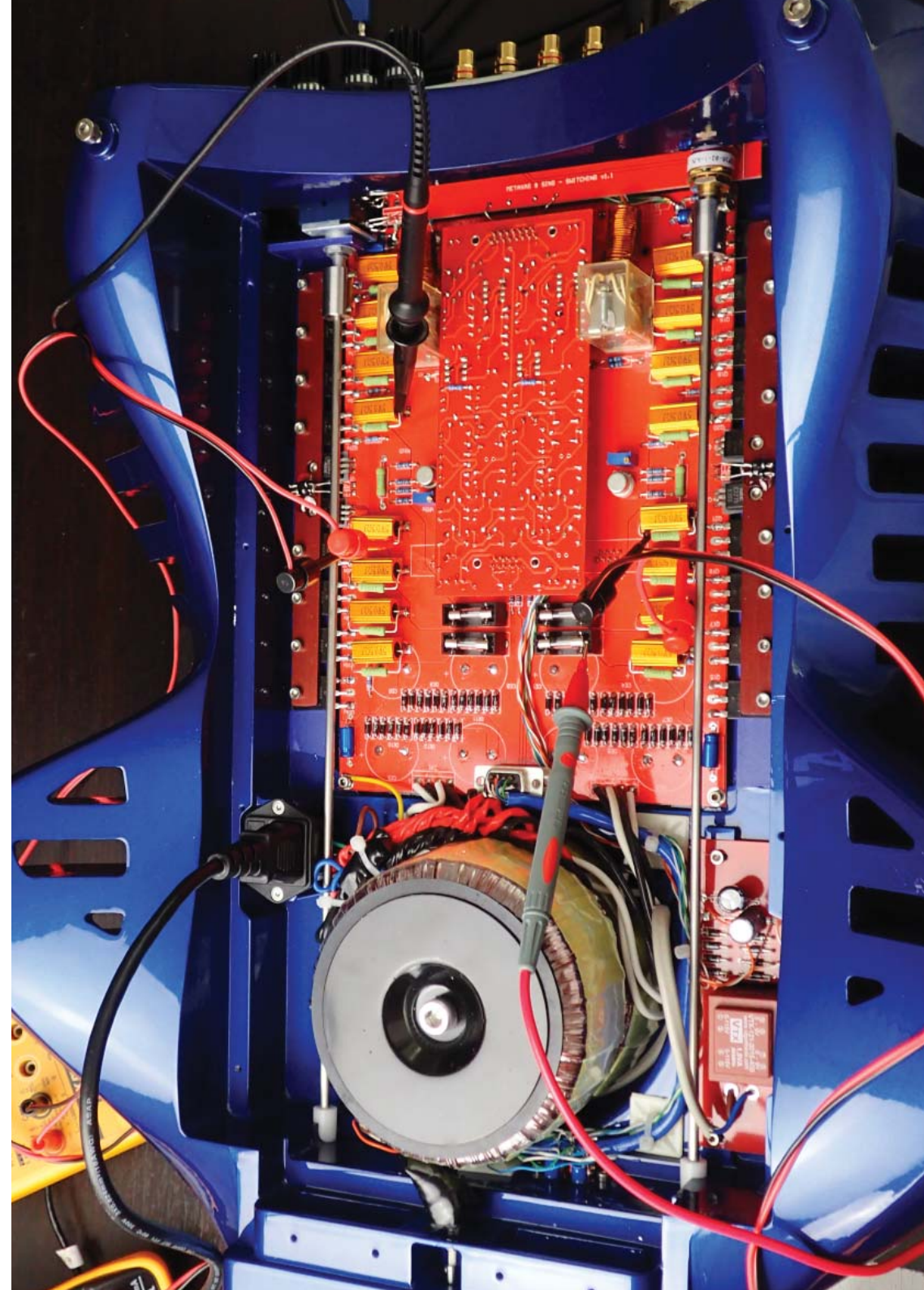







# the making of a solitaire

These videos trace the creative and  
manufacturing process of a SOLITAIRE.

<https://vimeo.com/179023630>





# unpacking and connecting

## UNPACKING

Carefully remove the SOLITAIRE from it's FOAM PACKING taking note of how it's inserted [in case you wish to reuse the Flight Case for future transport].

Using the Alun-key set, you can remove the top amplifier module cover and bottom plate to ensure that the 2 amplifier modules and one VU module haven't become unseated from their PCB connectors during transit.

## Steps for Connection

1. Ensure that the front ON/OFF switch is in the OFF position before connecting the amplifier into your system [VU lights are OFF].
2. Once connected, ensure that there are no 'short circuits' in the speaker wires, then proceed to switch the unit ON.

For the best results, it is recommended that the unit is powered on for at least 15 minutes before critical listening is attempted.

**Protection Circuits**The output stage of the amplifier is fused with +/- 3A fast blow fuses [M205 type] which protects the amplifier in case of operating faults. Two 4-pole high current relays with DC sensing protection is also included.

**Mains Fuse:** [240V - 5AMP , 115V -10A ] A SLOW BLOW DA205 Type fuse is next to the AC MAINS SOCKET located on the underside of the amplifier.

If this blows, simply replace with the same rating fuse. If the fuse continues to blow, please contact us immediately, but also refer to the Maintenance Section of this manual for further instructions.





After unpacking, don't forget to remove the "white foam" which holds the modules in place - top and bottom panels.

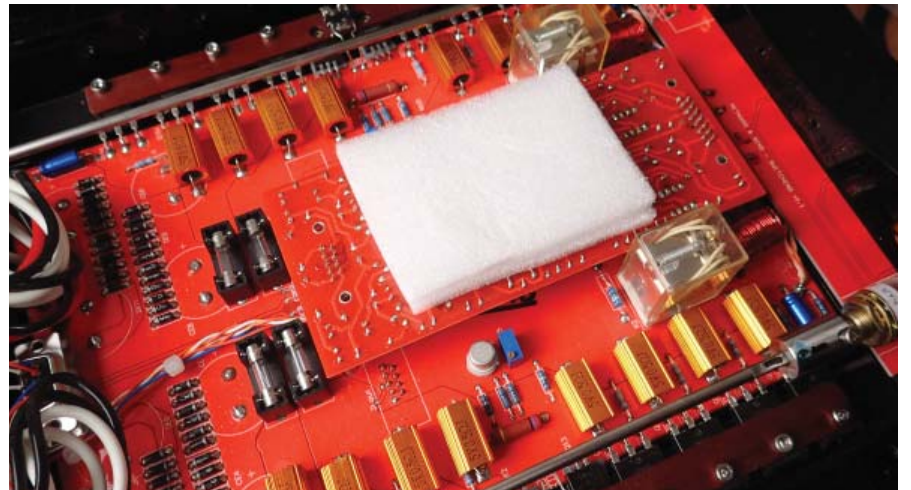
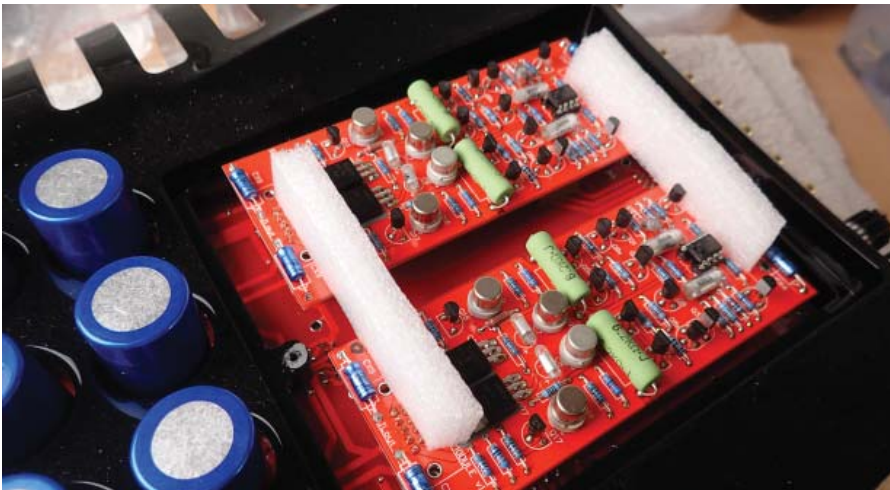



FUTURE-PROOF modular  
construction

the "heart" of  
the solitaire-  
two updatable modules

# PERFECT SOUND?

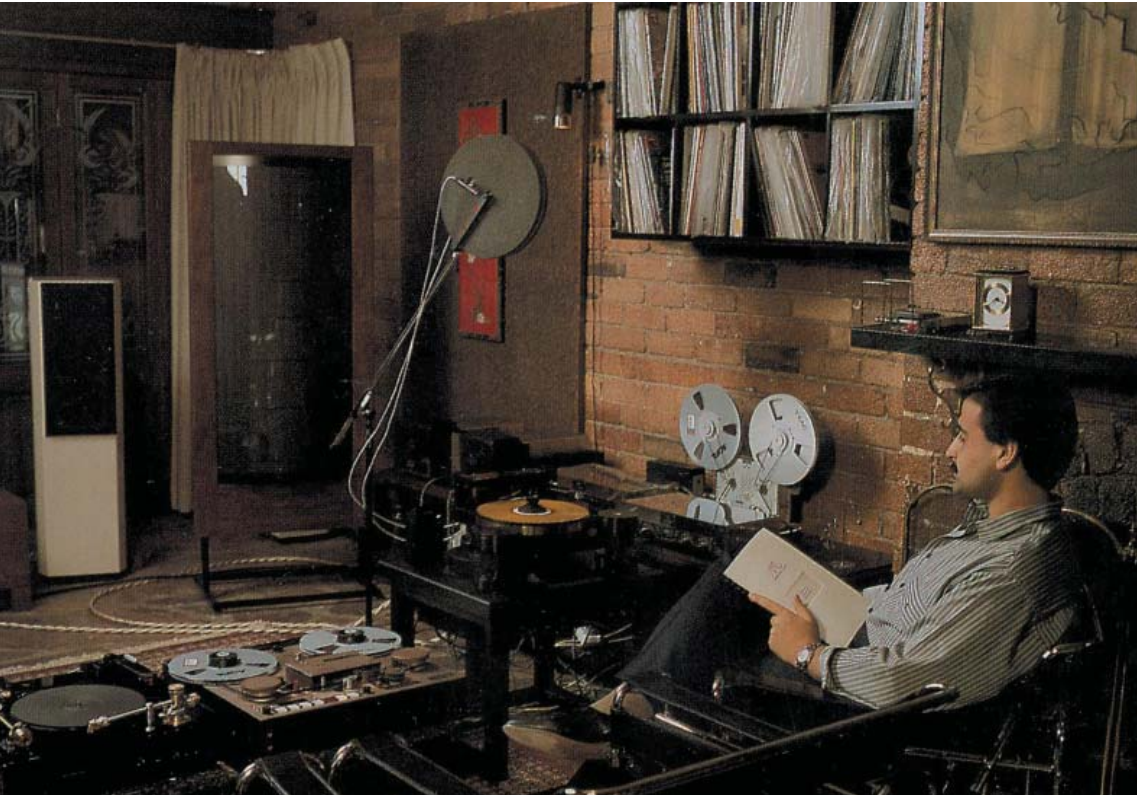

If the words you think of when listening include - effortless, transparent, engaging, holographic, real...then you are close. More than that, you need to "feel" the performance. It MUST move you.

The only way to design audio equipment with these qualities is to have first-hand experience with the finest available recording equipment AND playback equipment.

This is important for two reasons; it ensures that your designs work and 'mate-well' with other products and that their resolution is not limited by the weakest link in the playback 'chain'.

Metaxas amplifiers have been conceived using extensive listening tests with a variety of state-of-the-art ancillary equipment [and the systems of customers] over a 35 year period.

Our amplifiers have been designed using a variety of state-of-the-art phono playback equipment over the years but our ABSOLUTE REFERENCE is our library of over 300 in-house Master Tapes of acoustic Jazz and Classical concerts recorded using our Metaxas-modified battery-powered Stellavox SM-8 [and TD9] Tape Recorders with AGFA 468 1/4" tape recording using Bruel & Kjaer 4135 1/4" instrumentation and modified NEUMANN TLM-50 and M150 condenser microphones.

Digital copies of these recording "Masters" are freely available to our customers.

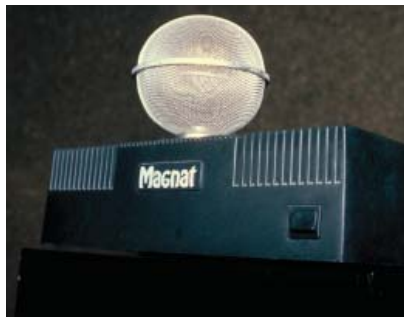





# what the critics said



"Listener A "There is not much else to say except that the SOLITAIRE leaves far behind our best references".

Listener B " Let's get straight to the point; MAS electronics are more than surprising, they are a real discovery, a rare find. Rarely have we heard on transistor units such liquidity, such an ease of reproduction where voices once again find melody and softness'

Jean Hirage/Patrick Vercher LA NOUVELLE REVUE DU SON, France.

" The Solitaire is yet another solid state amplifier that I liked from the first time I heard it in my system. It passed very musical and unharsh sounds through to the speakers. Its sound is characterised by exquisite spatial presentations, solid dynamics, great transparency and a tonality that is a little soft sounding in the high frequencies. This amp is lyrical and quick sounding.

A Bascom H. King thumbs up for this one!" Bascom King, AUDIO USA

"This amplifier, once it stops pouting and stamping its feet, has definition, transparency, clarity and solidity which will charm the pants off anyone who regards imaging and detail retrieval as paramount".

Ken Kessler, HI FI NEWS & RECORD REVIEW, England."

"The Solitaire is more impertable, more steady, more precise and subsonically more tremendous than any SUMO power station of multiple power output. Furthermore, the Solitaire isn't picky at all with speaker principles. A complex dynamic 4 way speaker like Infinity Kappa 8, it brings the amp to top performance as do the extremely difficult electrostatic speakers of Putz or the old Martin Logan CLS. The real astonishment is met, however if one connects against all odds, the Metaxas power amp with the brilliant 300DM loudspeaker like the Energy Point IE. Then the Canadian shoe box sounds immediately like a noble speaker of ten times the price, surprises with bass extension, midrange resolution, transparency and easiness of treble ..."

Ulrich Michalik HI FI EXCLUSIV, Germany.



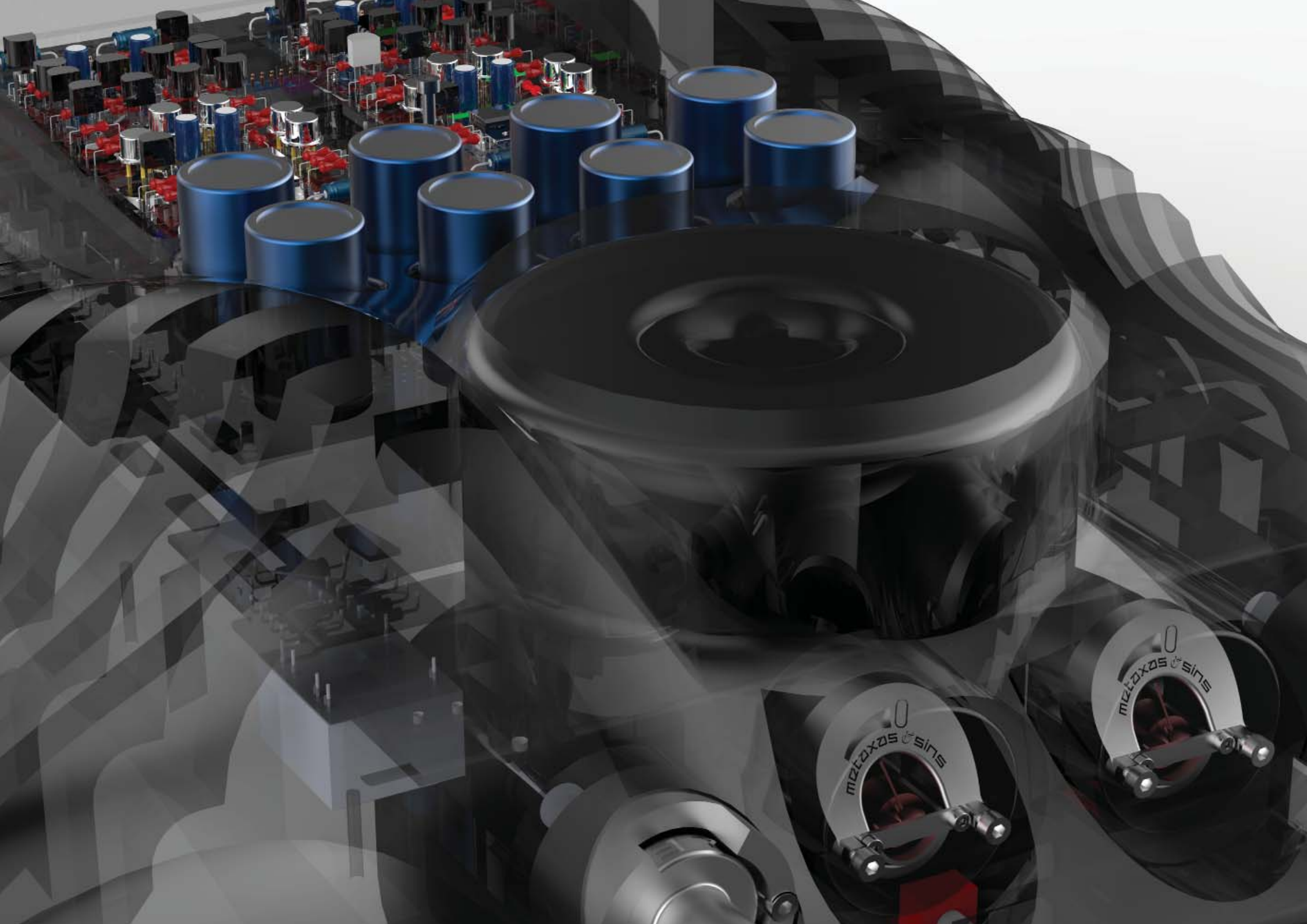

# what the critics said

" A pampered Solitaire will produce a vast soundstage with easily discerned and clearly positioned borders, with the musical event placed solidly in its own, uncompromised space and despite its sledgehammer slam, the Solitaire is capable of separating the brutal from the delicate, preserving the relationship between notes at either end of the dynamic frame".  
HI FI CHOICE GUIDE TO HIGH END , England.

"The poweramp specifically had no difficulty driving loads, even of the B&W 801FS and Analysis type (Greek, Apogee clones). In all other aspects the combination is very relaxed, with excellent plasticity and three dimensional body, excellent descriptive ability of the recording location (especially with the Celestion Kingston) and equally good rendering of the air.

"The performance of various frequencies can, in two words, be described as extremely homogeneous. You will not be able to tell them apart in well recorded material, with able three way transducers. Such a composure exists! The bass is very quick with top grade body and attack, not slowing at all. The mids are very descriptive, with very good detail and purity, soft and extremely sweet. The highs are delicate, with excellent body and special plasticity. The stereo image has excellent dimensions and very good "black" character, and by saying this, I mean the "black" space that separates the instruments and makes them sound as separate entities, with lifelike positioning in space, in well recorded material."

Thanassis Moraitis, SOUND & HI FI ,ATHENS, GREECE

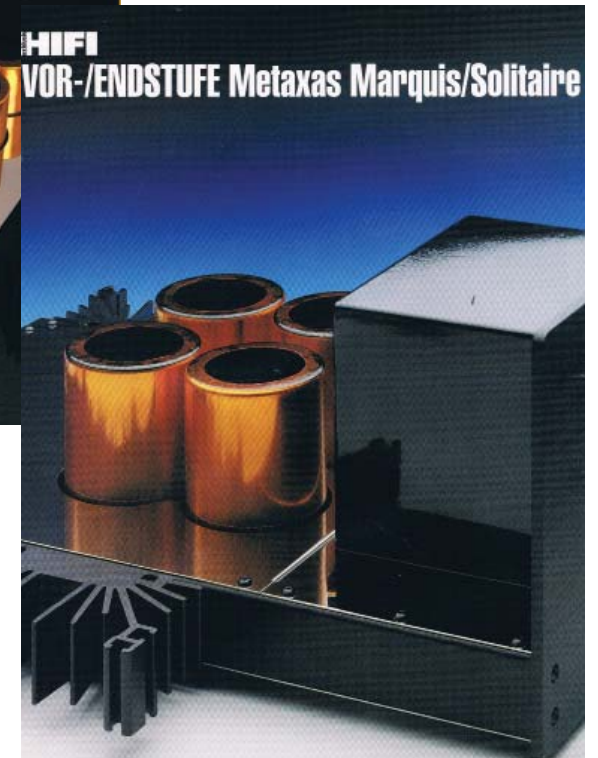
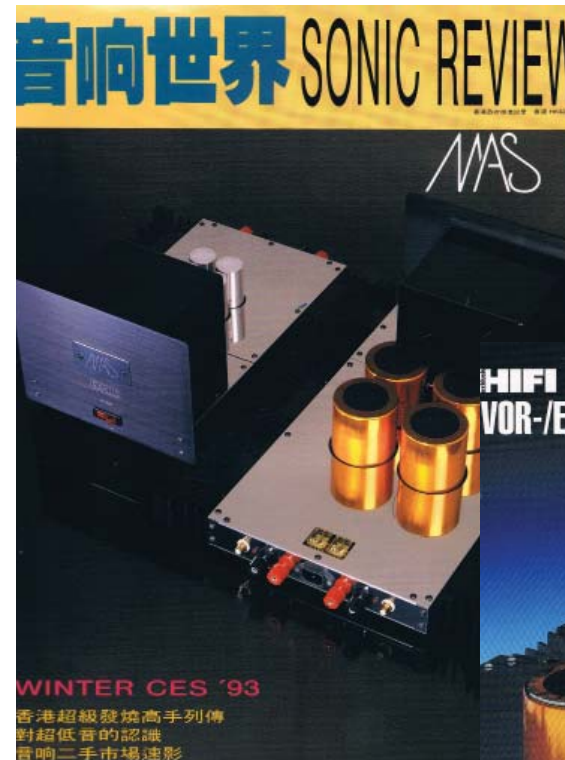



# history

4 decades of design - 1980's in Brunswick Street, North Fitzroy

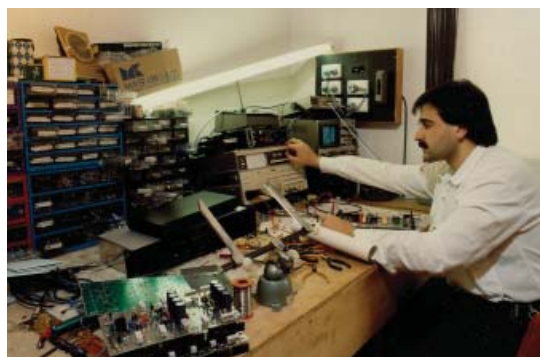
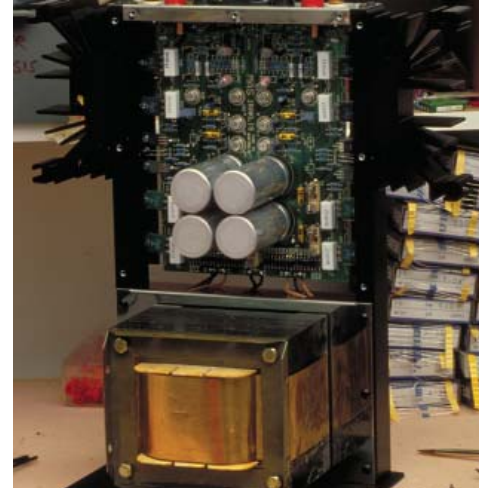
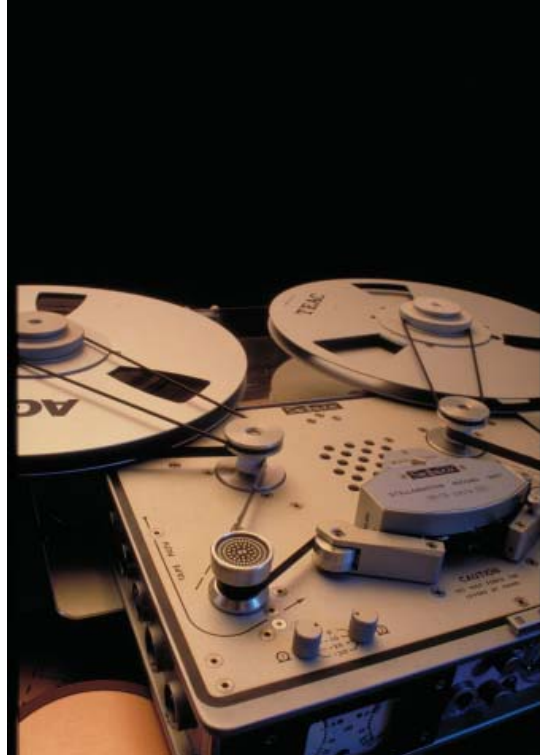



# history

4 decades of design - 1990's in Rae St, North Fitzroy & Macquarie St, Prahran.

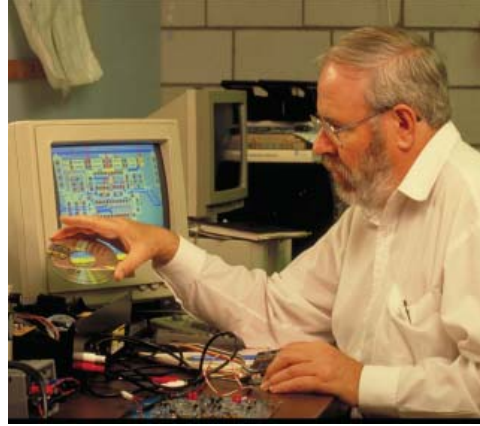

2000 designs  
Stainless Steel  
monocoque  
construction

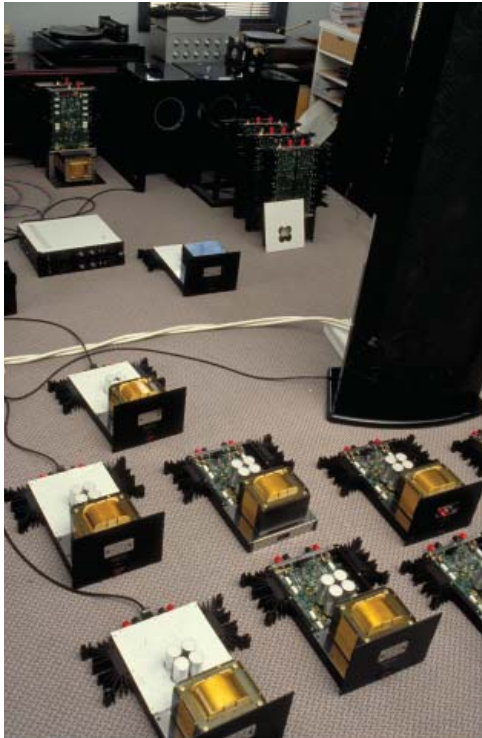

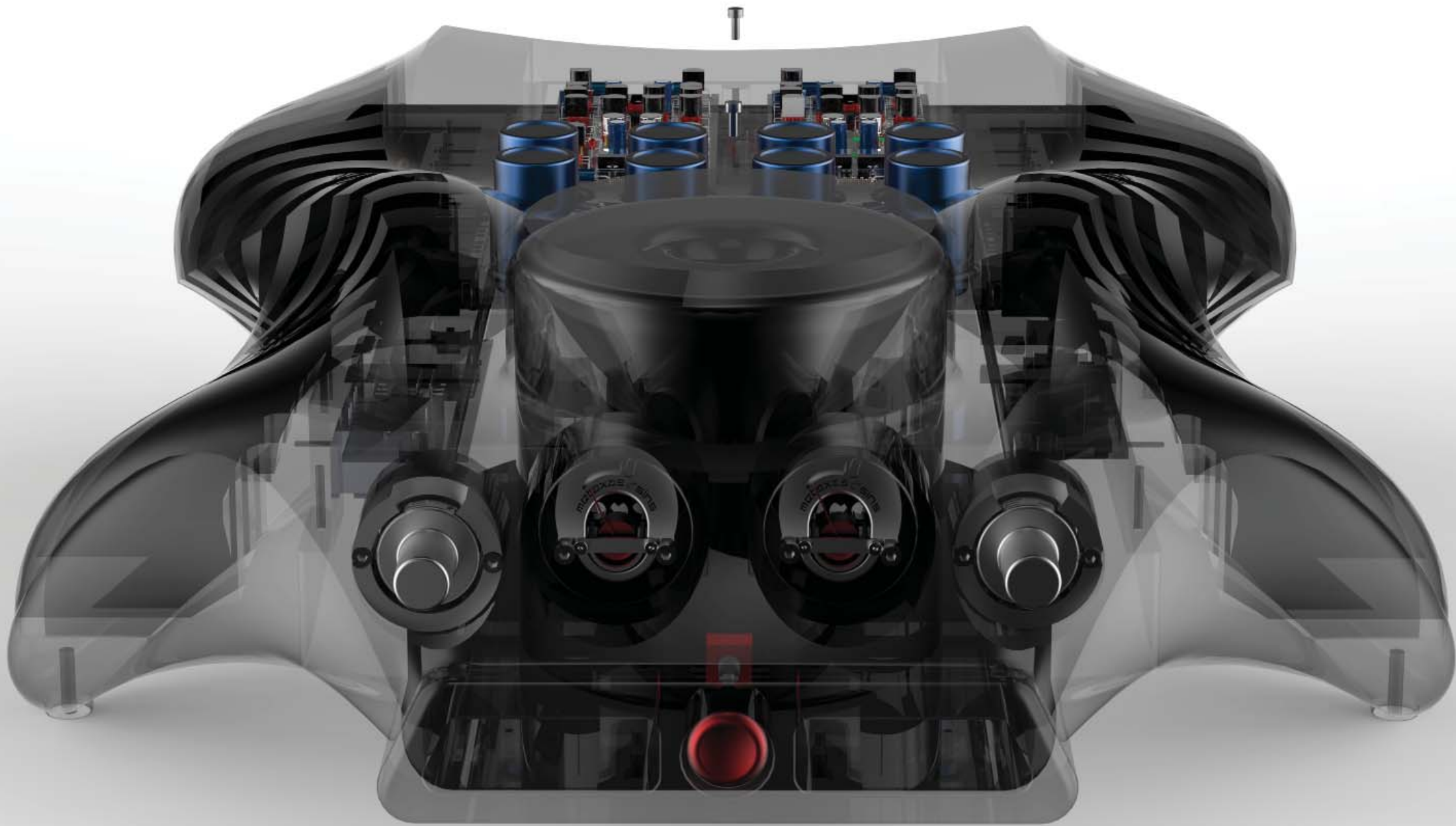





our master tapes







Georges Quellet & Kostas Metaxas 1986



# master tape concert recordings

If your concert recording equipment is “exceptional”, you are at least 90% towards creating a great recording - it is then really up to the musicians.

It’s actually the same with Hi-End Audio. An exceptional system somehow actually makes MORE recordings sound interesting and involving.

Because there is no equivalent to a Hi-End press in the professional recording world, you are really on your own when it comes to assembling a “reference quality” recording system. And there are only a few individuals who “Hi-End Audiophiles” know who actually have some knowledge in this field. How can you tell if they are good or not? Simple. Listen to their recordings.

The professional world doesn’t share the same vocabulary of “soundstage width and depth”, “tonal neutrality” and “transparency”. In fact, most recording engineers [and there are very few exceptions ] pick their microphones and equipment for the “known” colorations they impart to the sound. And the “sound” they tend to go for in general, has no depth of field as they are used to working in enclosed cubicles.

Acoustic music - Jazz and Classical, has been hardest hit. There are so many versions of Beethoven’s 5th [and most of the classic repertoire] recorded since the 50’s that there is no market for more “versions”. New Jazz recordings suffer the same “re-issue” fate. Why would you want to buy a modern recorded version of Miles Davis’ compositions and arrangements when you can purchase an exceptional 1950’s/1960’s re-issue of Miles Davis in 100, 200, 400gm vinyl?

Tuning or Voicing your equipment and making sure it can handle the levels of the music you want to record, is similar to selecting and assembling an Audio "playback" system.

My first recording in 1987 with my Stellavox SM8 and a pair of B&K 4133 mics convinced me that it could be the basis of a "reference" recording system with a performance beyond the best existing vinyl playback systems. I made up my mind very early on to ignore the pro-industry approach and instead focus on an almost Hi-End playback approach using the best recordings from the 60's as examples of what was possible - recordings from Bob Fine [Mercury], Ken Wilkinson [DECCA] and Lewis Layton [RCA], and of course a lot of experimenting during real recording sessions [mostly at the rehearsals].

The first experimentation was with microphones. Although I liked some of the colourations I could hear with AKGs, NEUMANNs, SCHOEPS etc, some were adversely affecting the soundstage width and depth of a performance. I found that the faster 1/4" or 1/2" diaphragm microphones soundstaged better than the traditional 1" capsules . So I started with a B&K 4133 which is predominantly used for instrumentation testing. It was transparent enough that I could start to hear some of the limitations of the Stellavox SM8.

Georges Quellet is one of my heroes. His machine is mechanically the equivalent of a Patek Phillipe watch. He has picked his compromises well in terms of the sound quality of this machine. His very simple two-stage single-ended, battery operated [13V] modules are exceptional when you remove all the "unnecessary" compensations, limiters, etc needed for normal professional use.

Earthworks, B&K 4135 , Neumann TLM50



3 modified Stellavox SM8's & AMI48 Mixer



Pair Neumann TLM50



BMW EDGE Concert Series [sponsored by BMW]



I could tell from my first recordings that he had gotten their soundstaging properties right. All that was missing were issues with forming 3D images on that soundstage because of “pro” circuit practices.

I replace the ceramic compensation caps used in the feedback loops, record and playback equalization with “blended” polystyrenes.

I also replaced the electrolytics in the signal path , rewired the signal path and the final huge improvement came with the substitution of a Lundahl mic transformer [I538XL] for the existing BEYER.

Apart from one small glitch during a concert, the modified SM8’s and AMI48 mixers have worked flawlessly through over 300 concerts - testament to the genius of Quellet!

VIDEO: Metaxas speech on recording at the Munich High End Show 2012: <https://vimeo.com/144719554>

The inner workings of one of 3 Stellavox SM8’s



K.D. Lang launch of “ALL YOU CAN EAT” CD at Kostas Metaxas Hotel “BYBLOS” in 1997



# design philosophy

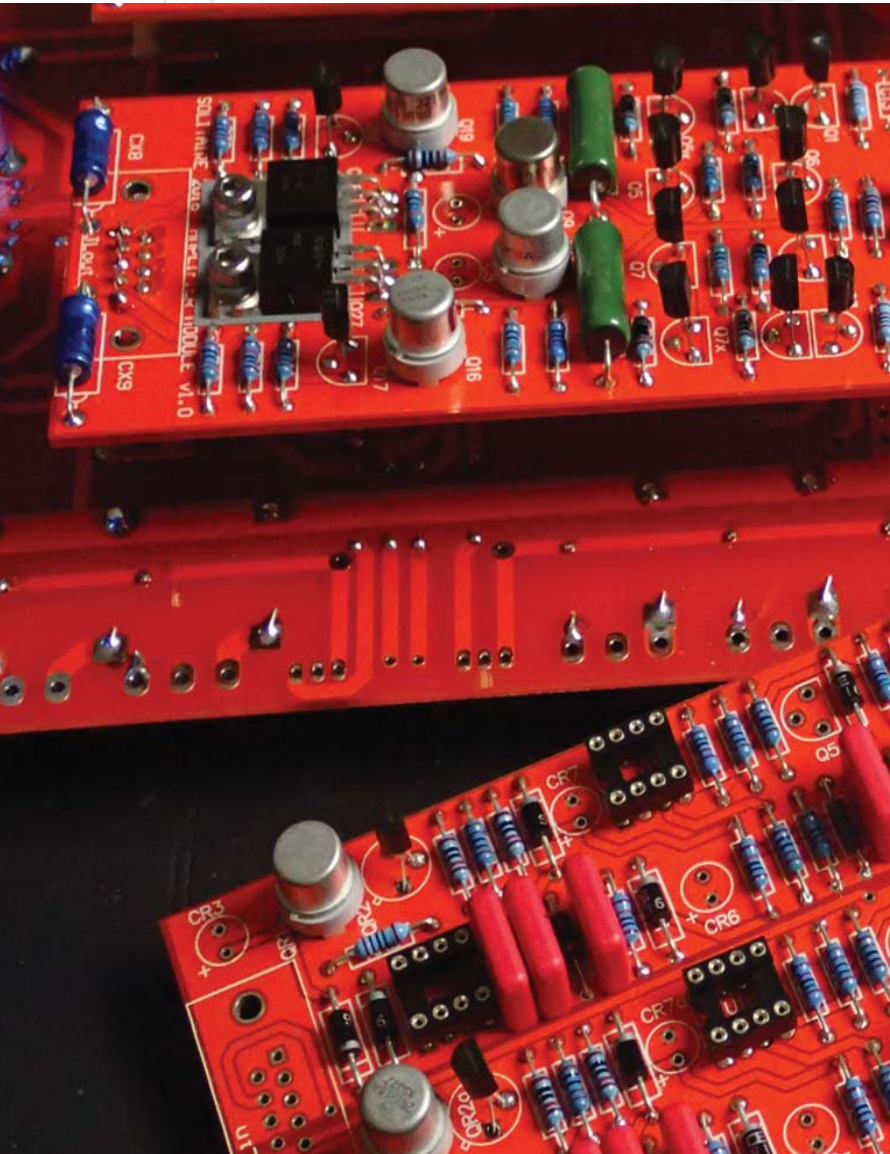

## ULTRA-SHORT SIGNAL PATH : NO-WIRE DESIGN

A prominent audio designer once described an amplifier as "A straight piece of wire with gain". We take this further by featuring the shortest possible signal path in a commercial amplifier. We minimize wire in any of our signal path and every component is directly soldered to one large printed circuitboard. From input to output, the signal passes through no more than 150mm of P.C.track.

The transformer is connected with only 40mm of wiring to the PCboard. This is only possible with our unique construction which features the complete amplifier (including filtering capacitors) is assembled onto one single rectangular Printed Circuit Board where the four sides connect directly to the inputs and outputs, power transistors on their heat sinks and power transformer.

The audio signal passes through ONLY ONE TYPE OF WIRE which is the highspeed, wave controlled oxygen free copper of our PC board.

## HIGH SPEED POWER SUPPLIES

Conventional power amplifier use a large, high-current power transformer which feeds a 'high-current' bridge rectifier to convert the AC from the transformer into DC voltages which are then mains ripple filtered using massive, computer grade capacitors. The rectifier bridge that is normally used is relatively large, handles high-current and low voltage with very slow switching speeds because of its inherent high internal capacitance. It has a response time measured in milliseconds which if converted to frequency would mean that it would have a frequency response from DC to around 200Hz .

Frequencies above 1 kHz would be unable to draw current instantaneously from the power transformer and would need to rely on the charge stored in the power supply filtering capacitors. We replace this slow DC rectifier with ultra high speed diodes wired in parallel with switching times in 'nanoseconds' which when converted to audio frequencies have a frequency response from DC-10 MegaHertz. High and low frequency currents can be drawn from the power supply more effortlessly.

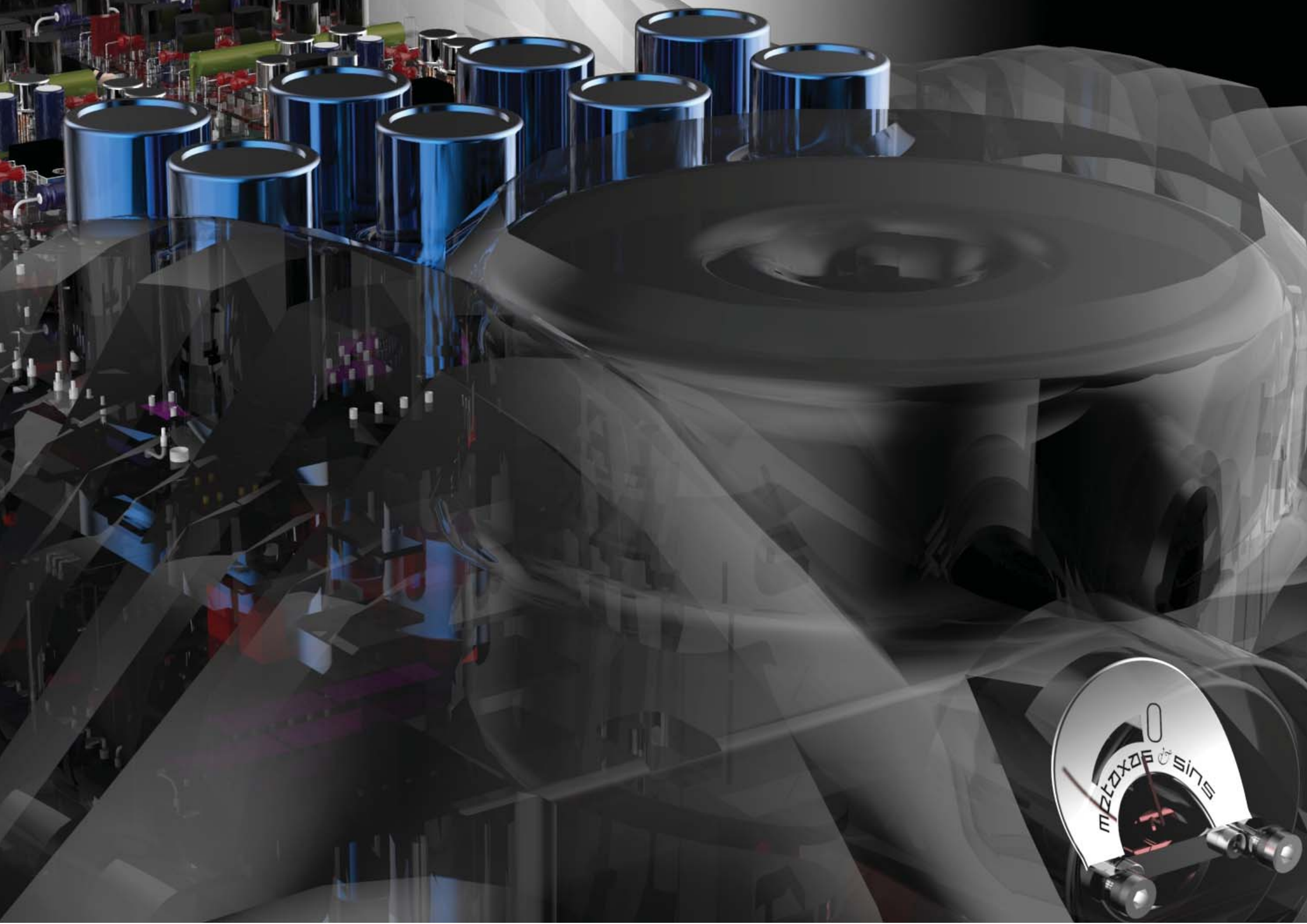

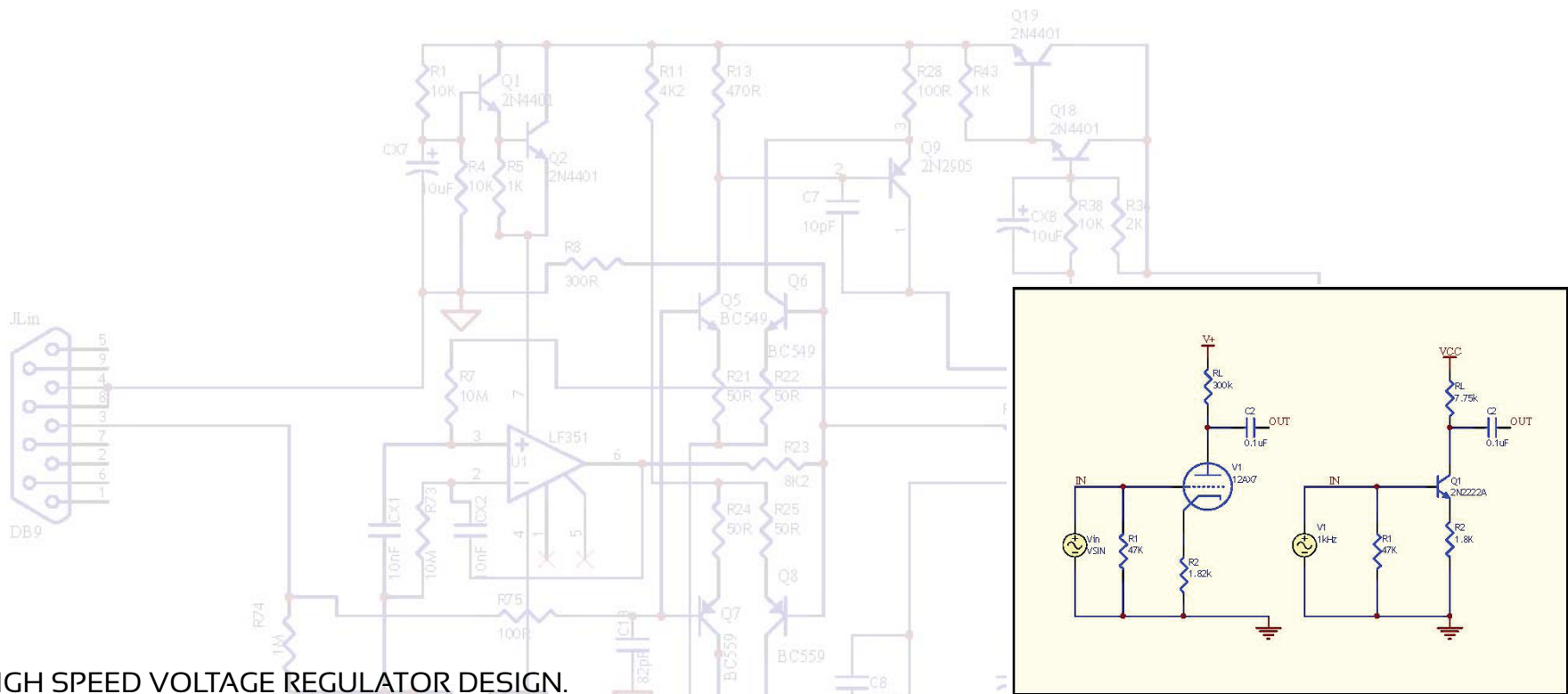

### LOW NOISE, HIGH SPEED VOLTAGE REGULATOR DESIGN.

The most significant difference between VALVE and TRANSISTOR circuits is the amplifier/power supply interaction. In VALVE amplifier, the high voltages (from 200-400 Volts DC) result in a 50,000 to 100,000 Ohms value for resistor R. The equivalent transistor amplifier using much lower voltages (from 12-30 Volts) would have a substantially lower value of R between 200 Ohms-100 Ohms.

A normal power supply in a transistor amplifier is more likely to affect the transistor amplifier circuit compared to a Valve amplifier circuit. If we assume that the regulator impedance at V+ is around 2 Ohms just for the purpose of this illustration, then let us study the amplitude of the 10VOLT sine wave as it goes through R and returns back to the OUTPUT of the TRANSISTOR circuit and VALVE circuit. In the VALVE circuit, when 10 VOLTS travels across the 50,000 Ohms R towards the power supply impedance of 2 Ohms, the 10V signal is attenuated  $50,000/2 = 25,000$  times.

Therefore  $10V/25,000 = 0.0004$  Volts of 1,0kHz sinewave. On its way back to the OUTPUT of the circuit it is attenuated by the impedance of the amplifier (say 100 Ohms):  $0.0004 \text{ Volts}/50,000/1,000 = 0.000008$  Volts. 0.000008 VOLTS of out of phase sine wave accompanies the 10 Volts sine wave as out-of-phase distortion in the VALVE CIRCUIT.

In a normal TRANSISTOR circuit, the 10 VOLTS going across the 200 Ohms resistor R would be attenuated only  $10/200/2 = 0.1$  VOLTS. On the way back to the output, the voltage is attenuated by:  $0.1V/200/1000 = 0.05$  VOLTS of out-of-phase sine wave added to the 10 VOLT output sine wave. In a normal Transistor circuit, the 'phase distortion' is 0.5% as compared to 0.000008% for a normal VALVE circuit.

Title	METAKAS AUDIO SYSTEMS IKARUS INTEGRATED AMPLIFIER
File	C:\DROPBOX\DESIGN\METAKAS_AUDIO_scb\PROJECT\ASSEMBLY\prot
Revision	
Sheet of	



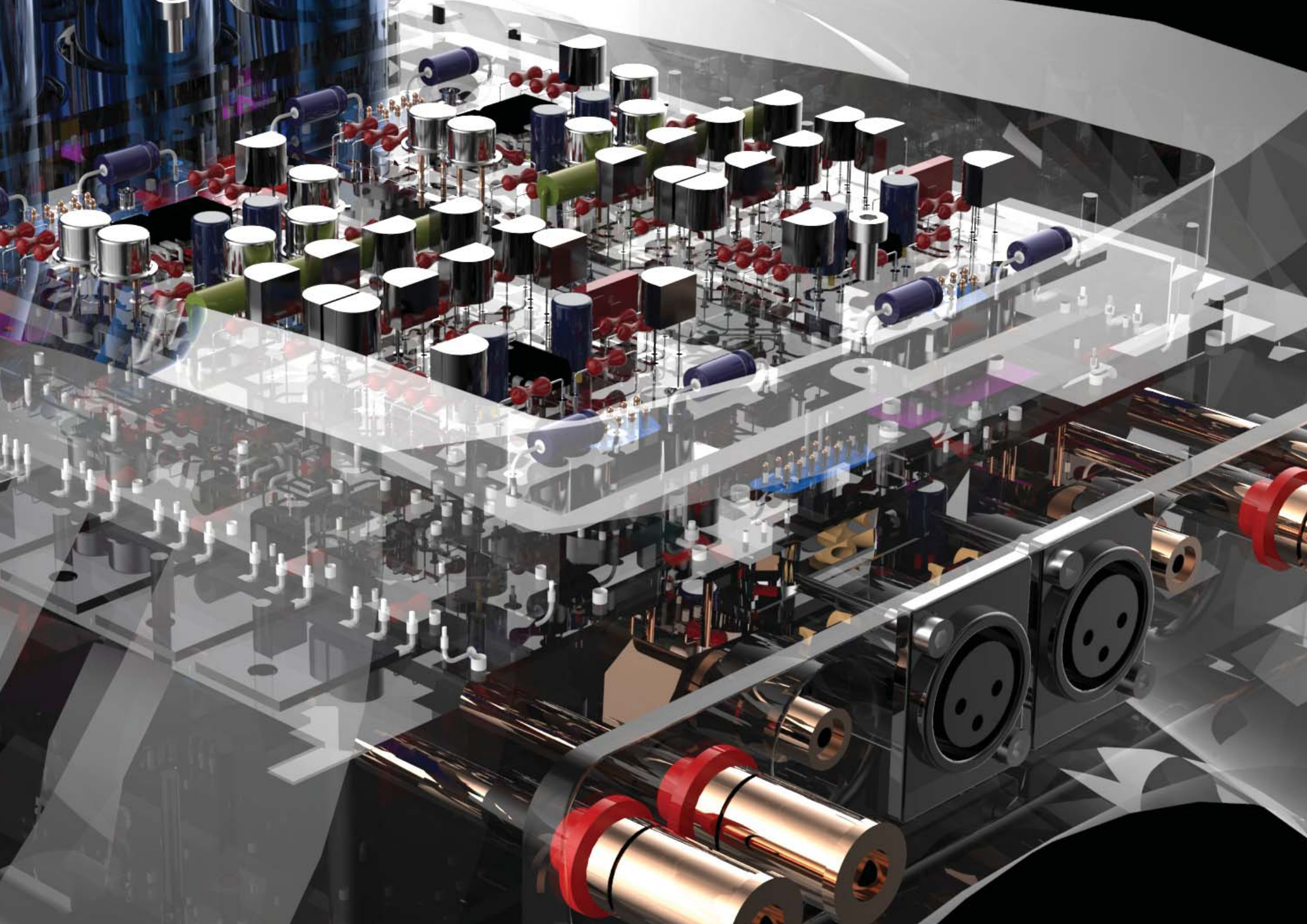

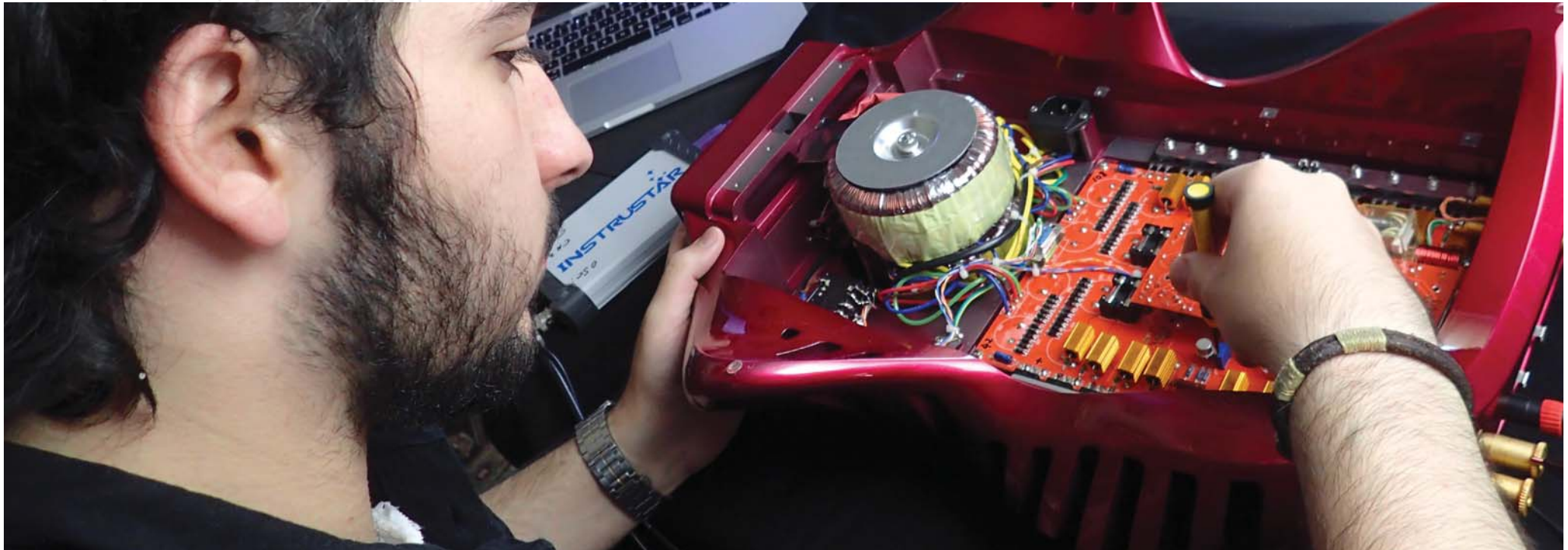

If we monitor the V+ point of the transistor circuit using an oscilloscope, we would notice this 0.1 Volts, 1.0 kHz signal. If we were to increase the frequency to 10,000 Hz and up to 1.0 MegaHertz the speed of dynamic behaviour of the power supply becomes critical. Using a normal I.C. regulator would result in the signal at V+ actually increasing in amplitude as the frequency increases so that at 1.0 MegaHertz the 1.0 Volt sine wave is now over 1.0 Volt!

To fully understand this interaction between the amplifier and power supply, it is necessary to understand how a voltage regulated power supply works. A voltage regulated power supply is essentially a D.C. amplifier (not unlike a normal power amplifier) which instead of having an audio signal at the input which is then amplified to become a larger audio signal at the output, has a fixed D.C. voltage reference at the input which is then amplified and becomes a larger DC voltage at the output. The output impedance of the regulator, not unlike the output impedance (or "Damping Factor") of a power amplifier is less than one ohm at D.C. If we use a 2.0 Volt zener diode as our fixed DC voltage reference at the input of the D.C. amplifier which has a gain of 10, the resulting output voltage is 20 Volts D.C. The negative feedback loop of the amplifier which fixes the gain of 10 times the 2.0 Volt zener reference is very important because it maintains the output voltage irrespective of an increase or decrease in the power supply voltage to the amplifier as long as there is a minimum voltage for the regulator circuit to operate (for a 12 Volt regulator, the minimum voltage is 15 Volts).

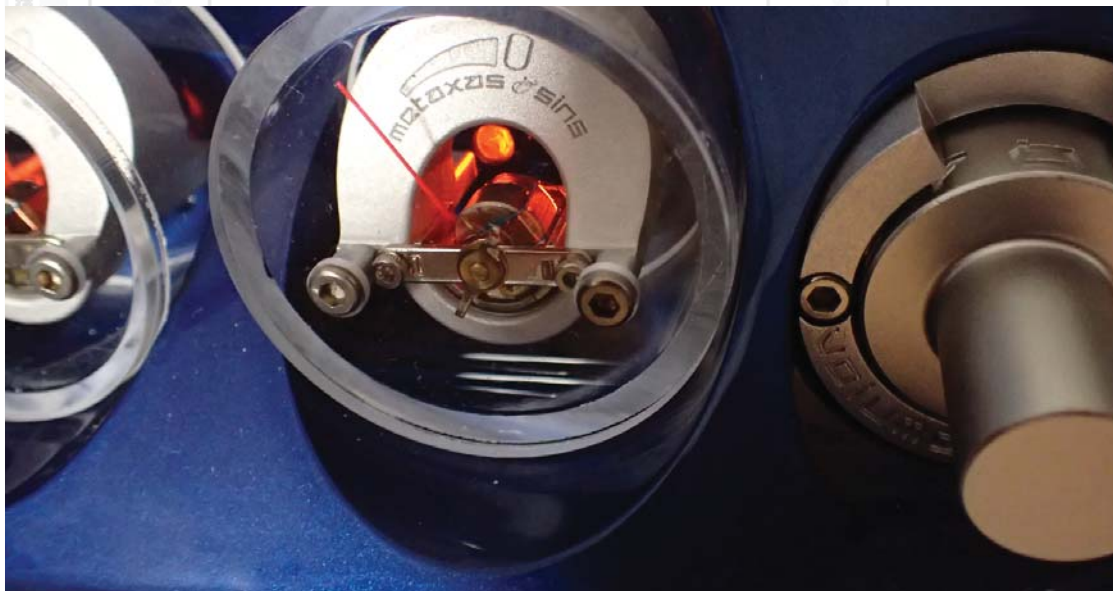

This is the STATIC performance of a voltage regulator which although important, does not affect the overall sound of the amplifier as much as the regulator's DYNAMIC performance which is influenced by the speed and 'open loop gain' of the regulator.

To understand why the Dynamic performance of a voltage regulator is so important, we need to go back to our basic amplifier circuit and investigate what happens to the 1.0 Hz, 10 Volt output signal as it goes across resistor R and encounters our voltage regulator.

To ensure an absolutely stable D.C. at  $V+$  the residual of the 10 Voltsine wave at the OUTPUT is fed through the negative feedback loop of the regulator to force the amplifier to correct this error by applying an inverted signal identical to the residual sine wave to totally eliminate the residual sine wave at  $V+$ .

A high speed regulator would therefore treat a signal at 1.0 MegaHertz in the same manner as a signal at 1.0kHz. The ultimate voltage regulator would effectively have a theoretical output impedance (or 'Damping Factor') at  $V+$  of zero ohms at all frequencies as a result of its wide bandwidth before the addition of negative feedback. In this way, the attenuation of the 10 Volts across the resistor R residual would be complete, and no attenuated component of the 10 VOLT sine wave could be deflected and return to the OUTPUT of the circuit and cause severe phase anomalies by adding to the new signal presented at the output - remember that it would take a few nanoseconds for the signal to go through the resistor and come back.

This extraneous out-of-phase information if allowed to add to the new OUTPUT signal, would then destroy TIME/ PHASE characteristics of the amplifier circuit. In real world power supply circuits, the impedance of the power supply actually increases with frequency because the open loop gain rolls off at high frequencies.

If we go back to our basic circuit and analysed the performance of an I.C. positive voltage regulator (say a LM78LXX from NATIONAL SEMI-CONDUCTORS) it would have an output impedance at the pin of its output lead of around 0.2 Ohms from DC to 10kHz, and then an increase to 0.4 Ohms at 20kHz, then 4.0 Ohms at 1 MEGAHERTZ which clearly illustrates the open loop frequency response has a turnover point around 10 kHz.

When you add the normal distance between the regulator output and amplifier circuits which may be as little as 60mm to as much as 200mm in many circuits, the overall impedance increases 5 to 10 times. Also, to stabilise the operation of this I.C. regulator, it is essential to use an output capacitor for stability. Clearly, this is not good enough for high performance, high speed transistor circuits.

For this reason, we have approached the design of our regulators as PART of our amplifier circuits, rather than make the fastest amplifier circuit and add a slow I.C. voltage regulator with an output capacitor and call it a finished design. Our discrete voltage regulators are designed to have the absolute lowest noise, reject mains ripple, but more importantly to have a speed (1000 V/microsecond) which is a result of their wide bandwidth design (an open loop frequency response greater than 500kHz) and output impedance which is an order of magnitude better than any I.C. The regulator stability is achieved without ANY capacitors by varying the ratio between the local and overall feedback of each device. We position the regulators within mm's of the active circuits (in the case of the OPULNCE, the regulator is 3mm! from the active circuits) and the regulator impedance is flat from DC to beyond 5 MegaHertz at less than 0.05 Ohms.

Beyond this electrical design aspect, we listen to the sound of our regulators whilst developing each amplifier circuit to ensure that every component change or substitution produces an audible improvement from the selection of transistors to best biasing currents, choice of voltage references zeners and degree of local feedback

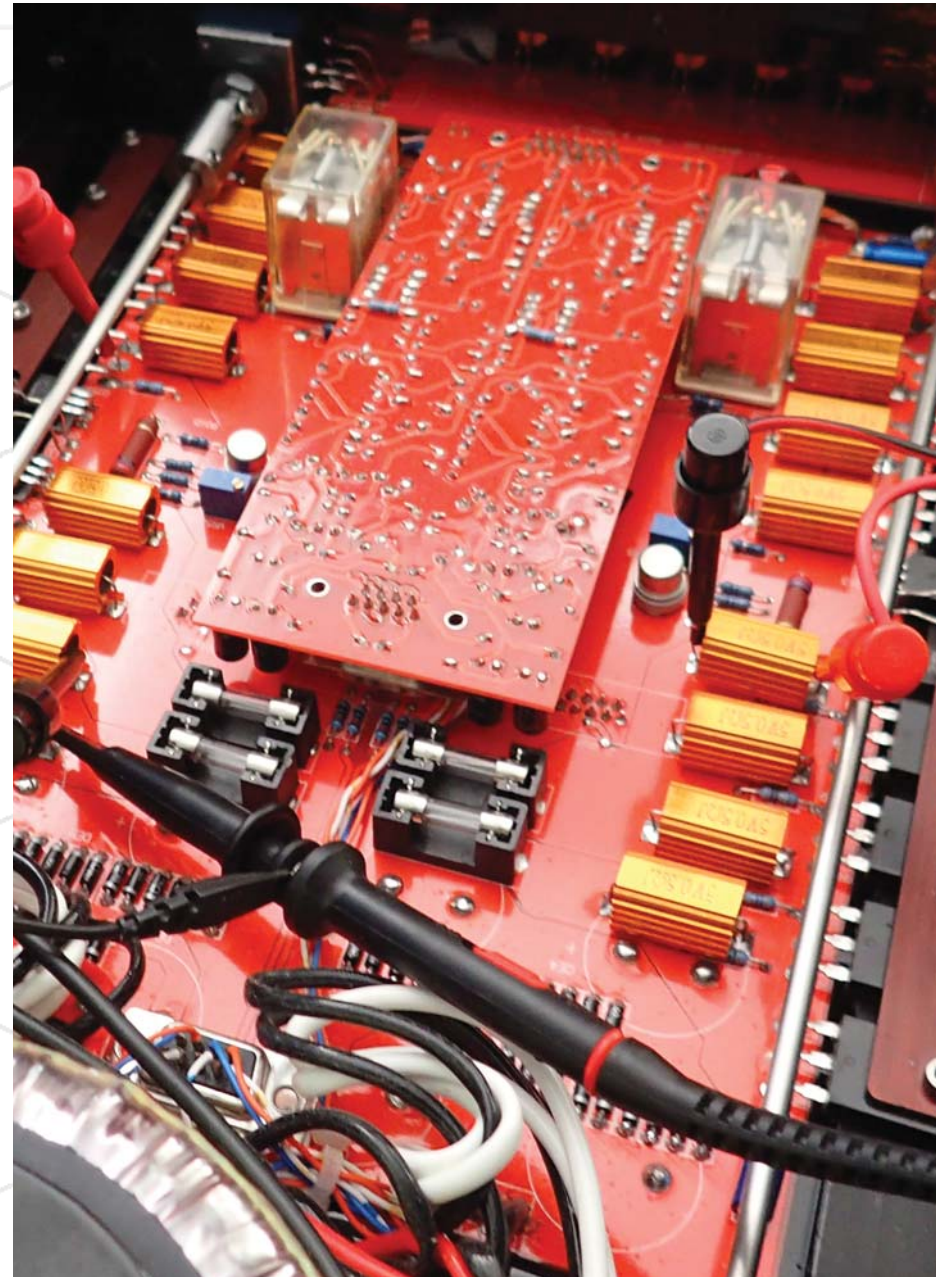

A close-up photograph of a watch movement, showing the intricate mechanical parts and a prominent red rotor. The movement is housed in a metal case back, which is partially visible. The background is a blurred, dark surface with some blue and red highlights.

**solitario**

anodized option - any color you like



# maintenanco

## TESTING

### TOOLS REQUIRED:

Dual Channel Oscilloscope  
Signal Generator  
30V x 2 Power Supply  
Multimeter

1. Flip the amplifier to reveal the underside and remove the bottom panel [M3 alun bolts]. Remove the VU Module. Rotate the biasing trimpots VR5 & VR5a fully clockwise.

2. Connect the + and - and GND supply lines at the FUSEHOLDERS or CENTER PIN OF POWER TRANSISTORS [+ 2987, - 1227] to the external current limiting Power Supply with maximum +/- 35VDC output voltage and 100 mA current limiting

3. Generate a 1.0kHz frequency sine wave. Connect your oscillator to any of the inputs 1,2,3 and select it with the rotary switch. Adjust the VOLUME control to position 9. Connect the Speaker outputs to your Oscilloscope's channel 2.

4. Install or replace the 4 fuses with MA205 [FAST BLOW] 1.0 A [for extra safety]

5. Power the module on and check that there is no current limiting.

You should now be able to see the amplifier output on the Oscilloscope ch2.

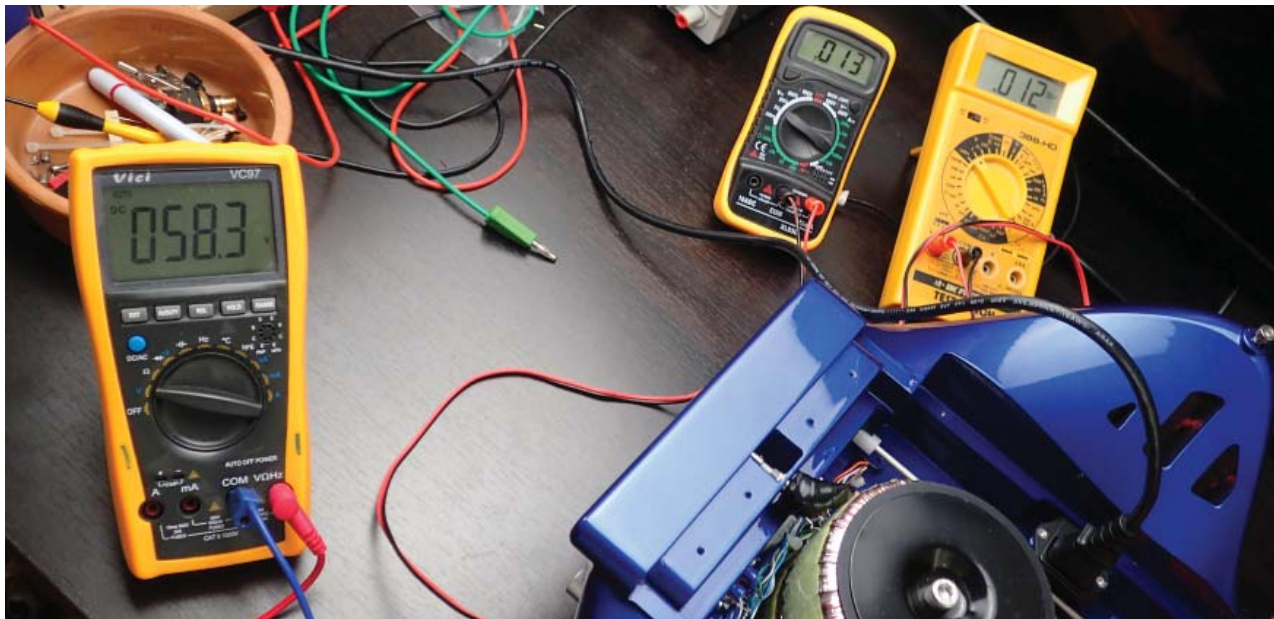
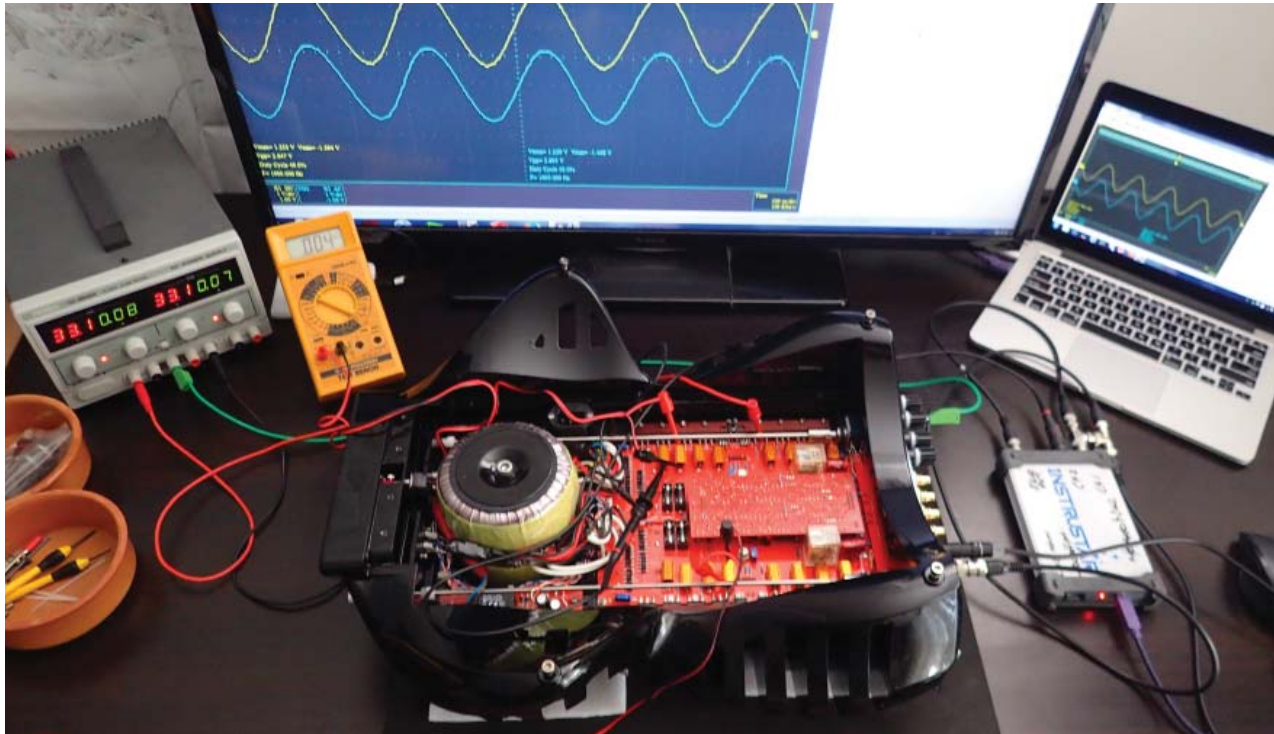



6. To test the “capacity multipliers” on the amplifier modules , measure the voltage across the collector & emitter of Q2,4,16,19] which should drop approximately 2 volts . If a greater value is measured, replace the faulty transistor.

7. Clip a multimeter across any of the 0.5 OHMS output stage emitter resistors and rotate the 18-turn trimpot slowly anti-clockwise until you measure approx. 0.015 VDC across this resistor. Maintain for 30 minutes, adjusting the trimpot as the amp warms up.

#### IF A FUSE BLOWS

1. Measure the DC resistance between any of the three leads of the transistors Q14-21 and Q14a-21a [the transistors mounted on the heatsink]. If you measure less than 100 Ohms between any two leads, the device is faulty and must be replaced. NOTE: If the TO220 driver transistor is faulty, replace both driver transistors [Q12 & Q13 or Q12a & Q13a].

2. Check the 30 OHMS resistors in series with the BASE of the output transistors [R39,40,39a,40a] to ensure that they have not “open circuited”.

3. Connect the BLACK multi meter lead to earth and check for any short circuits on the positive or negative voltage rails.

4. If the MAIN FUSE blows check the SF16 rectifier diodes in case one diode is short circuited [damaged]. If they measure less than 100 Ohms, replace them.

5. DC Offset Voltage at Output. Connect multimeter probes to the speaker terminals to measure the DC offset. It should be less than 0.05VDC. If it is greater than this please check the LF351 DC SERVO IC[UI]. Check that it is receiving voltage at Pin 4 (-15V) and Pin 7 (+15V) and replace if necessary.

6. Biasing Trimpot has no effect. Replace the 2N3019 transistor next to the TRIMPOT.

FAULTY MODULES [Amplifier and VU] can be returned to us for servicing and replacement.

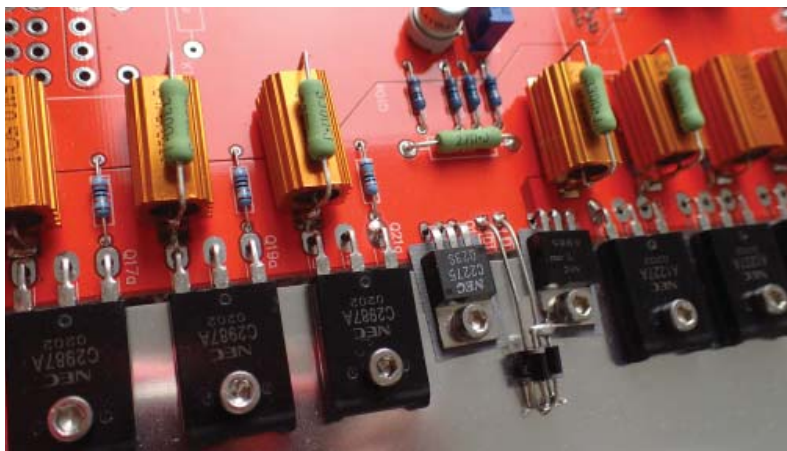



# SOME AWARDS

Recipient of 2 AUSTRALIAN EXPORT AWARDS,  
BHP STEEL DESIGN AWARD,  
runner up in AUSTRALIAN SMALL BUSINESS AWARDS.  
USA: International Design Award  
ITALY: A'DESIGN SILVER AWARD WINNER



## Certificate of Excellence

*This is to certify that*

*Kostas Metaxas & Sins*

*has won the Silver A' Design Award  
in Bathroom Furniture and Sanitary Ware Design Category  
in 2014 - 2015 period with design #36279:  
Oasis - Bathroom Sanitaryware*



Oasis by Kostas Metaxas  
<https://competition.adesignaward.com/design.php?ID>

**About The Silver A' Design Award**  
The Silver A' Design Award is a prestigious award given to top 1% percentile designs that has achieved an exemplary level of excellence in design. The designs are judged by a panel of three different Jury which is composed of 5 Academic, 5 Professional and 5 Focus Group Members for each different competition. The designs are evaluated with score normalization to remove any biases and are voted on aspects such as functionality, ergonomics, engineering, presentation, innovation, usability, fun details, technology, and any other specific points that could be considered, each of these points are further weighted for different jury groups.



15 April 2015, Milan / Italy.

*Alexander Dierckx*  
PRESIDENT  
A' DESIGN AWARD & COMPETITION

*Francoise Murru*  
VICE-PRESIDENT  
A' DESIGN AWARD & COMPETITION

*Olav Madsen Colbran*  
COORDINATOR  
A' DESIGN AWARD & COMPETITION

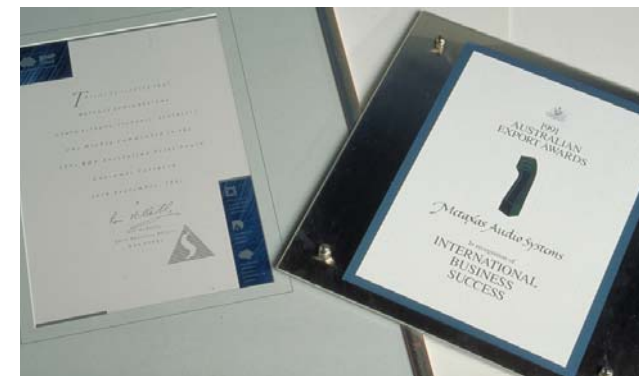



Meet Mr. Kostas Metaxas, an award winning artist and audio designer, electrical and recording engineer, Magazine Editor/Publisher and a Filmmaker/Broadcast Producer who covers fashion, design, gastronomy and the arts with over 1000 documentary interviews and two awarded feature films [[www.ikon.tv](http://www.ikon.tv)] to his credit.

Drawn to the shapes and textures of old master painters and sculpture since he was a teenager, about the same time, he was introduced to Hi Fi equipment and fell in love with the art of the reproduction of music. To him, art and design is “visual music”. Unable to afford expensive Hi Fi equipment, he taught himself electrical engineering and started producing, which turned into his first business. Hungry for knowledge about art and design, Metaxas started a magazine so he could interview great artists and designers worldwide, learn from them, and feed his own creativity.

For Metaxas, designing feels euphoric. He enjoys working with various materials – metal, glass, ceramic, plastic and subverting technology, like using dental techniques to create jewelry and watches. Both the traditional manufacturing methods and the latest software or their combination work great for him. He thinks of the big picture first, then the details and the best methods to create them.

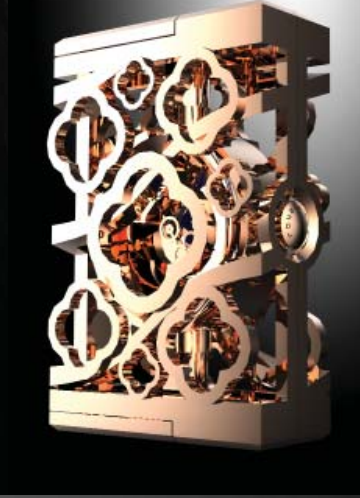
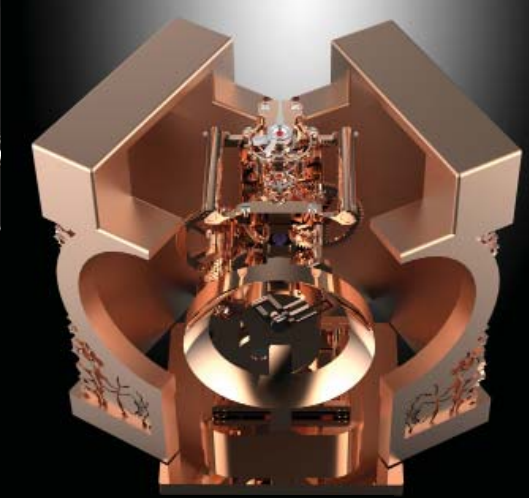

He strongly believes in balance with a twist, in the fight between the chaos and control, and a little intrigue thrown in. A bit of theatre, and a bit of utility – there needs to be substance, it should be useful, and it should also invoke experimenting and playfulness with infinite possibilities..

Some advice from Metaxas to young designers:  
“Research the breathtaking work of others, and wait until your idea exceeds that standard, otherwise it has no reason to exist. Do your absolute best. If you’re not motivated, don’t do it. Give life to an object which never existed before”.

That’s what he’s doing, and he loves every moment of it.



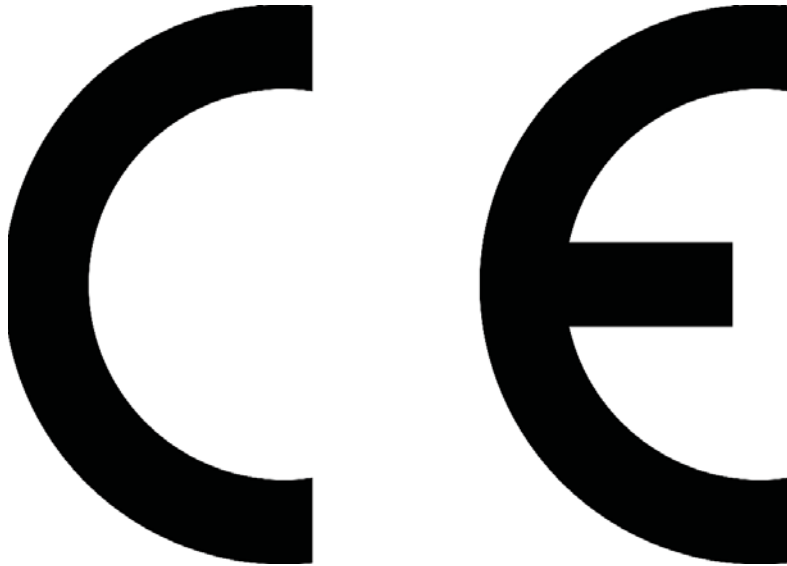

## EC Declaration of Conformity

Metaxas & Sins declare under sole responsibility that the SOLITAIRE AMPLIFIER to which this declaration relates is in conformity with the following standard(s) or other normative document(s).

Directives this equipment complies with:

LVD – 2006/95/EC  
EMC – 2004/108/EC  
ErP – 2009/125/EC  
RoHS – 2011/65/EC

Amsterdam / 12 January, 2017

Mr. Kostas Metaxas  
Owner/Designer,  
Metaxas & Sins BV  
Overschiestraat 184  
1062XK Amsterdam  
THE NETHERLANDS  
KVK 66427282 , VAT:NL 856548431B01